



CNA-2 camera control network adaptor



Monitor, configure and control your Sony system cameras anywhere with Network. Get your live camera systems ready for remote and distributed production, connecting multiple units to take on the most ambitious multi-camera projects. Run productions from your chosen connected location to get the most out of your system cameras and visualize grouping functions and settings for SR-Live and Networked Live.

NETWORKED **LIVE**

Export PDF

Where to buy



Watch Now

Monitoring and configuring your camera systems

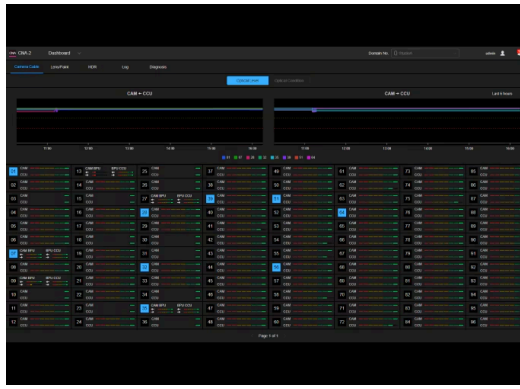

By accessing Web UI from a PC, tablet, or other device via a web browser, it is possible to centrally manage and monitor the camera network system, such as displaying the fiber condition of system camera devices on the network, monitoring alerts, and checking setting parameters during HDR/SDR simul-production. It also supports logging of errors and warning data. In addition, with the Compare function, it is possible to check whether the OETF settings are same as other cameras during HDR production.

Secure, web-based access



Enhance the security of your system through authentication and seamless integration with the GMCS or Web API.

Install the Web API license, HZC-GWCN2, in CNA-2 to establish a robust and secure connection. Regardless of your team's location, our secure Web API empowers them to manage format settings, camera painting, RCP assignments, and previews seamlessly across your distributed production environment.

Flexible and scalable for every production



Deploy a CNA-2 at each of your sites then manage your camera systems centrally. Connect multiple units and enjoy integrated system management across your operation, wherever your operators and controllers are working.

The Master function of the camera system

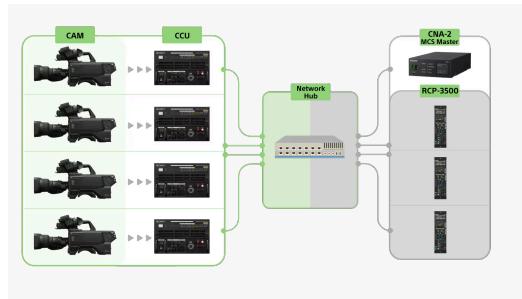

When operating a system camera with a Multi Camera System (MCS), it is possible to use this device as the Master equipment of MCS system.

WEB-RCP: Web-based multi camera remote control



Add the WEB-RCP license (HZC-RCPCN2) to the CNA-2 to control up to 12 cameras, directly from a browser on your PC or tablet—no dedicated application required. The interface delivers an experience similar to a physical RCP panel, streamlining setup, as well as gain, iris, white balance, and other adjustments. For studio switching or upgrades, it offers expandability for multiple operators across different sites, while the intuitive browser-based UI reduces training time and improves consistency, stability, and allows simple updates, such as PTZ camera support.

WEB-MSU : Comprehensive multi camera management

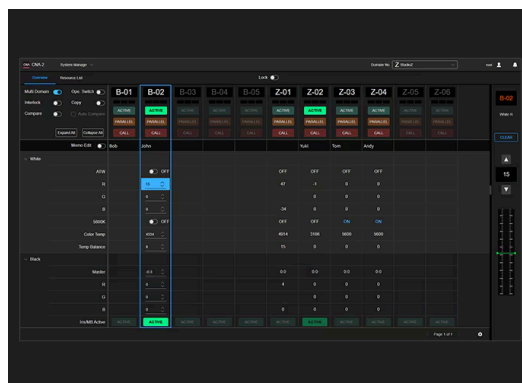

All the power and control of a physical MSU control panel in an intuitive browser interface. With the WEB-MSU (HZC-MSUCN2) installed on a CNA-2, system management, parameter configuration, and file copy/control is all accessible via a simple browser log in, enabling simultaneous multi-user collaboration. Standardise operations across studios by saving and copying parameters between connected cameras, then ensure consistency with side-by-side comparisons of settings. It's an ideal solution for domain-based workflows, with RCP assignment switching across studios or OB Vans, IP-based Networked Live, and full compatibility with GMCS, to provide a scalable foundation for remote and multi-site production.

Clear, compact control



With its compact size, CNA-2 can display IP addresses and version/license information on its electronic paper display. Meanwhile, the web UI visualises grouping functions and settings for SR-Live and Networked Live.

Device log aggregation and visualisation

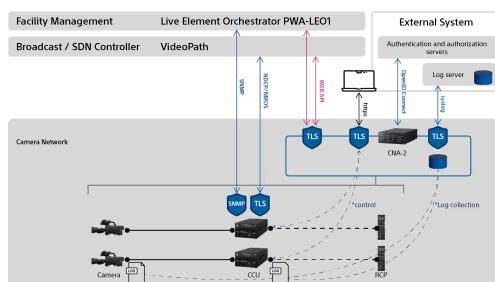

Collect and consolidate log data from your devices, with clear visualisations.

Configuration data

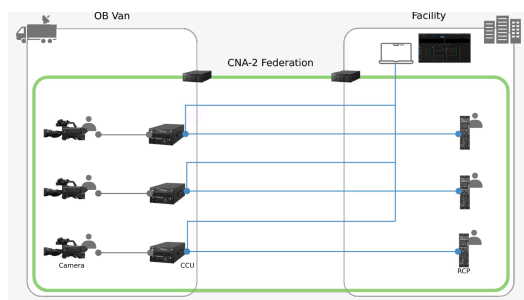

Handle configuration data for your distributed devices and enable federated control for flexible, efficient productions.

A gateway to third party devices

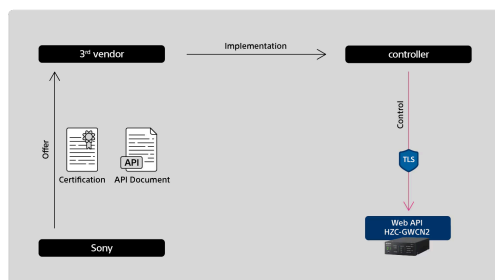

Combine your Sony camera systems with third party devices, thanks to our secure web API.

GMCS (Global Multi Camera System)



GMCS* is a next-generation multi-camera control system. By using CNA-2 as the hub in a GMCS environment, setup efforts can be significantly reduced, and equipment resources can be utilized more effectively, enhancing overall production efficiency. The system's logically divided camera (Domain), a feature of GMCS, can be assigned to individual studio or OB VAN, allowing centralized monitoring and remote control across multiple domains.

**To configure the GMCS system, the CNA-2 requires firmware ver. 1.1 or later. Additionally, a firmware update on the camera side may be necessary.*

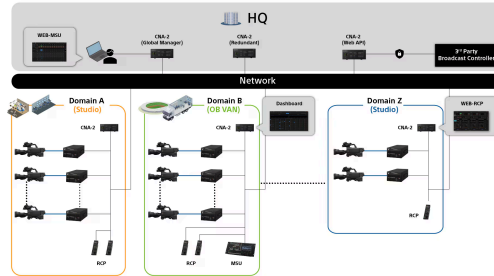

Protocol converter



Translate Sony's 700 protocol to and from Simple Protocol for work with third-party devices. This function also means the CNA-2 makes it possible to translate 700 protocol to and from the CCA cable to control devices.



E-Paper display

CNA-2 features e-paper display technology to demonstrate a paper-like display. This allows the customer to be able to clearly operate the adaptor even in direct sunlight. As a reflective display, it does not emit any light, which makes it energy-friendly.

Network redundancy ensures uninterrupted, secure connectivity

Network redundancy ensures uninterrupted, secure connectivity.



Featuring a DC IN power adaptor

The DC IN power adaptor enables redundant power supply implementation.

Want to learn how the CNA-2 can help you realise Networked Live production?

Contact us

Specifications

General

Power requirements	LAN1 PoE (IEEE802.3af Type1 Class0 compliant): DC 37 V – 57 V CCU power supply (CCA): DC 10.5 V – 30 V EXT I/O (D-SUB): DC 10.5 V – 17 V DC 12V IN: DC 11.4 V – 12.6 V 9 W (main unit only, DC 12V IN)
--------------------	--------------------------------------------------------------------------------------------------------------------------------------------------------------------------------------------------------------------------------

General

Operating temperature	5 °C to 40 °C (41 °F to 104 °F)
Storage temperature	-20 °C to +60 °C (-4 °F to +140 °F)
Dimensions (W x H x D)	100 mm × 42 mm × 181 mm (4 inches × 1 11/16 inches × 7 1/4 inches)
Weight	660 g (1 lb 7.3 oz)

Input/output connectors

CCU	8-pin multi-connector, jack (1)
LAN 1 to 2	RJ-45 (2) 1000BASE-T: IEEE 802.3ab
USB	High Speed USB (USB2.0) (1)

Supplied accessories

Supplied accessories	Before Using This Unit (1)
----------------------	----------------------------

Gallery



Accessories



HZC-RCPCN2
WEB RCP license for CNA-2



HZC-GWCN2
Web API License



HZC-MSUCN2
WEB MSU license for CNA-2

Related products



HDC-3500

Three 2/3-inch 4K CMOS sensors portable system camera for fibre operation



HDC-5500

High performance three 2/3-inch 4K CMOS sensor portable system camera with direct 4K output



HDC-P50

4K/HD compact POV system camera



HDC-P31

HD compact POV system camera with enhanced remote features and advanced HDR workflows



HDCU-5500

IP-ready Camera Control Unit (CCU) for HDC-5500 4K/HD system camera



HDCU-5000

Camera Control Unit (CCU) for HDC-5500 and HDC-3500/3100 series system cameras



HDCU-3500

IP-ready Camera Control Unit (CCU) for HDC-3500 4K/HD system camera



RCP-3500

Remote-control panel for HDC/HSC/HXC series cameras



RCP-3100

Joystick type of remote control panel for HDC/HSC/HXC series cameras.
5 units in 19-inch EIA rack.



MSU-3000

Master setup unit, multi camera remote control panel for system cameras (horizontal type)



MSU-3500

Master setup unit, multi camera remote control panel for system cameras (vertical type)

CNA-2 Camera Control Network Adaptor - Sony Pro

© 2004 - 2026 Sony Corporation. All rights reserved. Reproduction in whole or in part without written permission is prohibited. Features and specifications are subject to change without notice. The values for mass and dimension are approximate. All trademarks are the property of their respective owners.