

Media Block

取扱説明書 2 ページ

JP

Operating Instructions Page 14

GB

お買い上げいただきありがとうございます。

 **警告** 電気製品は安全のための注意事項を守らないと、
火災や人身事故になることがあります。

この取扱説明書には、事故を防ぐための重要な注意事項と製品の取り扱いかたを示しています。この取扱説明書をよくお読みのうえ、製品を安全にお使いください。お読みになったあとは、いつでも見られるところに必ず保管してください。

付属の CD-ROM には、LMT-100 の取扱説明書（日本語、英語、フランス語、ドイツ語、イタリア語、スペイン語、中国語）が記録されています。詳しくは、6 ページの「CD-ROM マニュアルの使いかた」をご覧ください。

The supplied CD-ROM includes the Operating Instructions for the LMT-100 (English, Japanese, French, German, Italian, Spanish and Chinese versions). For more details, see “Using the CD-ROM Manual” on page 18.



LMT-100

安全のために

ソニー製品は安全に充分配慮して設計されています。しかし、電気製品はまちがった使いかたをすると、火災や感電などにより死亡や大けがなど人身事故につながることもあり、危険です。

事故を防ぐために次のことを必ずお守りください。

安全のための注意事項を守る

4 ページから 5 ページの注意事項をよくお読みください。

定期点検を実施する

1 年に一度は、内部の点検をお買い上げ店またはソニーのサービス窓口にご依頼ください（有料）。

故障したら使わない

すぐにお買い上げ店またはソニーのサービス窓口にご連絡ください。

万一、異常が起きたら

- 煙が出たら
- 異常な音、においがしたら
- 内部に水、異物が入ったら
- 製品を落としたりキャビネットを破損したときは



- ① 電源を切る。
- ② 電源コードや接続コードを抜く。
- ③ お買い上げ店またはソニーのサービス窓口にご連絡する。

炎が出たら

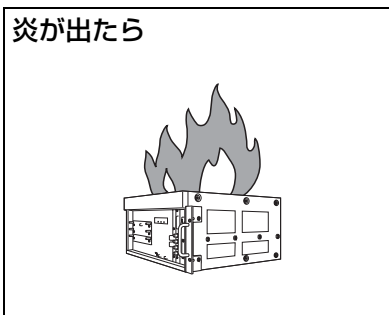

すぐに電源を切り、消火する。

警告表示の意味

取扱説明書および製品では、次のような表示をしています。表示の内容をよく理解してから本文をお読みください。



警告

この表示の注意事項を守らないと、火災や感電などにより死亡や大けがなど人身事故につながる可能性があります。



注意

この表示の注意事項を守らないと、感電やその他の事故によりけがをしたり周辺の物品に損害を与えたりすることがあります。

注意を促す記号



火災



感電

行為を禁止する記号



禁止



分解禁止

行為を指示する記号



指示



アース線を
接続せよ

目次

⚠ 警告.....	4
⚠ 注意.....	5
その他の安全上のご注意.....	5
本機の特長.....	6
CD-ROM マニュアルの使いかた.....	6
準備.....	6
CD-ROM マニュアルを読むには.....	6
各部の名称と働き.....	7
インジケータについて.....	9
故障かな?と思ったら.....	10
本機の性能を保持するために.....	11
アフターサービス.....	11
仕様.....	12
GNU GPL/LGPL 適用ソフトウェアに関する お知らせ.....	24



下記の注意を守らないと、
火災や感電により死亡や大けがに
つながることがあります。



分解禁止

外装をはずさない、改造しない

外装をはずしたり、改造したりすると、感電の原因となります。
内部の調整や設定および点検を行う必要がある場合は、必ずサービストレーニングを受けた技術者にご依頼ください。



指示

指定された電源コードを使用する

指定以外の電源コードを使用すると、火災や感電の原因となります。



指示

電源コードのプラグおよびコネクターは突き当たるまで差し込む

まっすぐに突き当たるまで差し込まないと、火災や感電の原因となります。



禁止

電源コードを傷つけない

電源コードを傷つけると、火災や感電の原因となることがあります。

- 設置時に、製品と壁やラック、棚などの間に、はさみこまない。
- 電源コードを加工したり、傷つけたりしない。
- 重いものをのせたり、引っ張ったりしない。
- 熱器具に近づけたり、加熱したりしない。
- 電源コードを抜くときは、必ずプラグをもって抜く。

万一、電源コードが傷んだら、お買い上げ店またはソニーのサービス窓口に交換をご依頼ください。



禁止

油煙、湯気、湿気、ほこりの多い場所では設置、使用しない

上記のような場所や、取扱説明書に記されている仕様条件以外の環境で使用すると、火災や感電の原因となることがあります。



指示

専用ブレーカまたはスイッチを設ける

本機には、電源スイッチがありますが、ラックマウント設置の際には、本機の近くの容易に接近できる屋内配線内に専用ブレーカやスイッチを設けるか、または本機の使用中でも容易に抜き差しできるコンセントに電源プラグを接続してください。

万一、異常が生じた場合は、専用ブレーカやスイッチを OFF にするか、電源プラグを抜いてください。



注意

下記の注意を守らないと、
けがをしたり周辺の物品に**損害**を
与えることがあります。



禁止

通気孔をふさがない

通気孔をふさぐと内部に熱がこもり、火災や故障の原因となることがあります。風通しをよくするために次の項目をお守りください。

- 壁から 10 cm 以上離して設置する。
- 密閉された狭い場所に押し込めない。
- 毛足の長い敷物（じゅうたんや布団など）の上に設置しない。
- 布などで包まない。
- あお向けや逆さまにしない。



指示

安定した場所に設置する

製品が倒れたり、搭載した機器が落下してけがをすることがあります。十分な強度がある水平な場所に設置してください。



アース線を
接続せよ

安全アースを接続する

安全アースを接続しないと、感電することがあります。
指定の電源コードを使用することで安全アースが接続されます。



禁止

ファンが止まったままの状態 で 使用しない

ファンモーターが故障すると火災の原因となることがあります。



指示

運搬するときは指定された場所 を持つ

運搬するときは底板を持ってください。そうでないと機器が落下してけがをすることがあります。

その他の安全上のご注意

注意

日本国内で使用する電源コードセットは、電気用品安全法で定める基準を満足した承認品が要求されます。ソニー推奨の電源コードセットをご使用下さい。

レーザー機器についての注意

ここに規定した以外の手順による制御および調整は、危険なレーザー放射の被爆をもたらします。

レーザー特性

波長	: 850 nm
発振形態	: 連続
レーザー出力	: 0.5 mW (max.)

本機の特長

メディアブロック LMT-100 は、SR プロジェクター SRX-R110 または SRX-R105 と組み合わせて、デジタルシネマの上映を可能にする劇場内のサーバーです。

DCI (Digital Cinema Initiative, LLC) 準拠

DCI の仕様に対応しています。デジタルシネマで配信される DCP (Digital Cinema Package) に含まれる 4K (4096 × 2160) および 2K (2048 × 1080) の JPEG2000 映像ファイルを再生し、SR プロジェクターに映像を出力します。

最大 16 チャンネルのデジタル音声信号再生

DCP に含まれる音声ファイルを、最大 16 チャンネルの AES/EBU デジタルオーディオ信号として出力します。

SMS (Screen Management System) に対応

SMS を搭載したコンピューターと接続して外部からコントロールすることにより、劇場での上映のための操作やテスト上映などの機能に幅広く対応できます。

外部の映画素材の上映も可能

外部入力スロットを装備しています。HD-SDI 信号や DC-SDI (2K) 信号対応などの別売インプットボードを装着することにより、外部出力装置から映画素材を入力することも可能です。

ライセンスに関するご注意

本機をご使用いただく前に、巻末のソフトウェアのライセンスに関するご注意 (24 ~ 38 ページ) をお読みください。お客様による本機の使用開始をもって、このお知らせの内容をご確認の上、ご同意いただけたものとさせていただきます。

CD-ROM マニュアルの使いかた

付属の CD-ROM には、本機の取扱説明書 (日本語、英語、フランス語、ドイツ語、イタリア語、スペイン語、中国語) が PDF 形式で記録されています。

準備

付属の CD-ROM に収納されている取扱説明書をご覧いただくためには、以下のソフトウェアがコンピューターにインストールされている必要があります。

- Adobe Reader 6.0 以上

メモ

Adobe Reader がインストールされていない場合は、下記 URL よりダウンロードできます。

<http://www.adobe.co.jp/products/acrobat/readstep2.html>

Adobe、および Adobe Reader は Adobe Systems Incorporated (アドビシステムズ社) の商標です。

CD-ROM マニュアルを読むには

CD-ROM に入っている取扱説明書を読むには、次のようにします。

1 CD-ROM を CD-ROM ドライブに入れる。

表紙ページが自動的にブラウザで表示されます。ブラウザで自動的に表示されないときは、CD-ROM に入っている index.htm ファイルをダブルクリックしてください。

2 読みたい取扱説明書を選択してクリックする。

取扱説明書の PDF ファイルが開きます。

メモ

Acrobat Reader のバージョンによって、ファイルが正しく表示されないことがあります。

正しく表示されない場合は、「準備」の項の URL より最新のソフトウェアをダウンロードしてお使いください。

ご注意

CD-ROM が破損または紛失したため、新しい CD-ROM をご希望の場合は、お買い上げ店またはソニーのサービス窓口にご依頼ください（有料）。

各部の名称と働き

前面

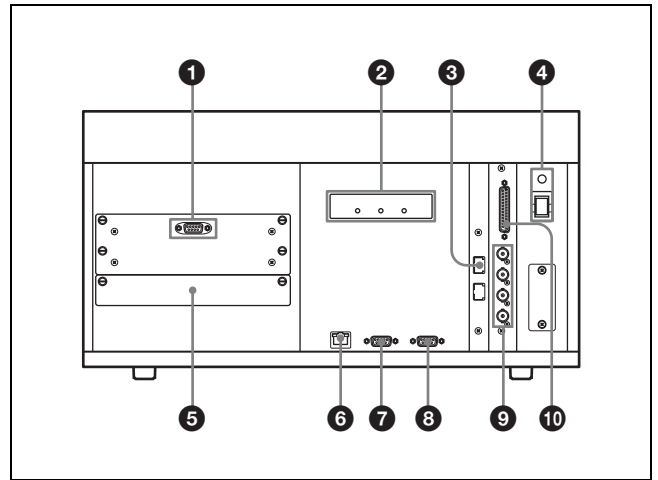

① RS-232C 2 端子 (D-sub 9 ピン、凹)

メンテナンス用の端子です。

② LED インジケーター

READY (スタンバイ) インジケーター：本機の後面と前面の電源スイッチを入りにすると点滅します。その後点灯に変わり、本機がスタンバイ状態になります。また、SMS を搭載したコンピューターで、本機の電源を切れる状態にすると点滅します。その後消灯したら、本機の電源スイッチで電源を切ることができます。

PLAY (再生) インジケーター：映像・音声再生中点灯します。

ALARM (警告) インジケーター：本機に障害が発生すると点灯します。

◆ 詳しくは、「インジケーターについて」（9 ページ）および「故障かな？と思ったら」（10 ページ）をご覧ください。

③ FIBRE CHANNEL (ファイバーチャンネル) 端子

DCP (Digital Cinema Package) ストレージ用の RAID (レイド) ディスクと、市販の光ファイバーケーブルで接続します。

お買い上げ時は、防塵カバーが取り付けられています。

④ I/O (サブ電源) スイッチと I/O インジケーター

後面の I/O スイッチが入り (I) の状態でこのスイッチの I 側を押すと電源が入り、I/O インジケーターが緑色に点灯します。READY インジケーターが点滅から点灯に変わり、本機がスタンバイ状態になります。

電源を切るときは、SMS を搭載したコンピューターで電源を切りにして READY インジケーターが消灯したら、 側を押します。

⑤ インットボード取り付け部

別売のインットボード LKRI-001 などを取り付けます。外部出力装置からの映像を入力できます。インットボードを取り付けるときは、お買い上げ店またはソニーのサービス窓口にお問い合わせください。

⑥ ETHERNET (イーサネット) 端子 (100BASE-TX/1000BASE-T)

DCP のインポートや上映操作をコントロールするコンピューターと、ネットワーク経由で通信するときに使用します。イーサネットケーブル (市販のケーブル) でスイッチングハブと接続します。

で注意

安全のために、周辺機器を接続する際は、過大電圧を持つ可能性があるコネクタをこの端子に接続しないでください。接続については本書の指示に従ってください。

⑦ RS-232C 1 端子 (D-sub 9 ピン、凹)

メンテナンス用の端子です。

⑧ SPARE (スペア) 端子 (D-sub 15 ピン、凹)

予備の端子です。

⑨ AUDIO OUTPUT (音声出力) (AES/EBU) 端子 (BNC 型)

オーディオシグナルプロセッサと接続します。最大 8 チャンネルのデジタルオーディオ信号を出力します。

⑩ AUDIO OUTPUT (音声出力) (AES/EBU) 端子 (D-sub 25 ピン、凹)

オーディオシグナルプロセッサと接続します。出荷時の設定では、チャンネル 1 からチャンネル 8 の信号が出力されます。(BNC 型の AUDIO OUTPUT 端子と同じ信号が出力されます。)

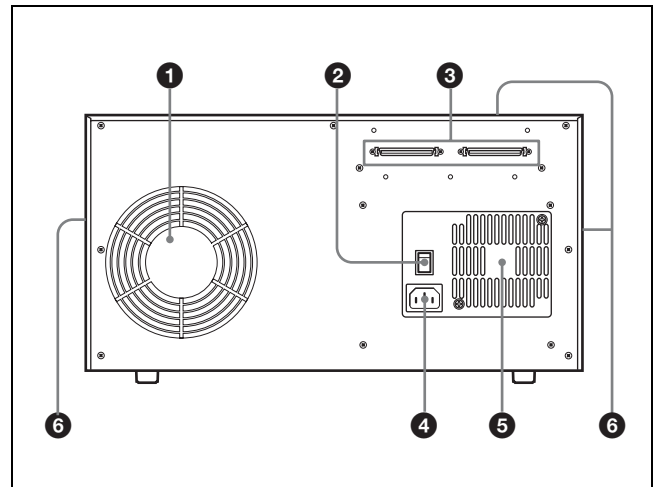

SMS 搭載のコンピューターの設定により、チャンネル 9 からチャンネル 16 の信号を出力することができます。

後面



① 排気口

② I/O (主電源) スイッチ

主電源を入り / 切りします。 を押すと主電源が入ります。電源を切るときは、前面の スイッチを切ってから  側を押します。

③ OUTPUT (出力) A/B 端子 (MDR 68 ピン)

本機に付属のプロジェクター用インットボード 2 枚を取り付けた SR プロジェクターに、付属の専用ケーブル 2 本で接続します。OUTPUT A 端子とプロジェクターの INPUT A スロットに取り付けたインットボードの端子、OUTPUT B 端子とプロジェクターの INPUT B スロットに取り付けたインットボードの端子とそれぞれ接続します。

④ AC IN 端子

3 芯の電源コード (市販) を接続します。接続はお買い上げ店またはソニーのサービス窓口にお問い合わせください。

⑤ 排気口

⑥ 吸気口 (上面 / 左右側面)

インジケータについて

本機前面のLED インジケータは、以下の場合に点灯または点滅します。

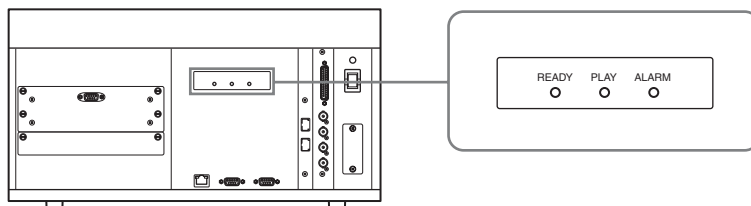

●：点灯 ✨：点滅 -：消灯

READY (スタンバイ)	PLAY (再生)	ALARM (警告)	意味
✨	-	-	本機後面と前面の電源スイッチを入れたあと、本機が起動中
●	-	-	本機がスタンバイ状態
●	-	●	スタンバイ時、本機に障害が発生した
●	●	-	再生中
●	●	●	再生中、本機に障害が発生した
✨	-	-	SMS 搭載のコンピューターでシャットダウンしたとき
-	-	-	シャットダウン後、本機の電源スイッチを切ってもよい状態（前面の I/O スイッチを切つてから後面の I/O スイッチを切ってください。）
✨	✨	✨	IP アドレスの初期化が完了した
✨	✨	-	本機に内蔵のテストパターン表示中

故障かな？と思ったら

修理に出す前に、もう一度次の点検をしてください。

以下の対処を行っても直らない場合は、お買い上げ店にお問い合わせください。

症状	原因	対処
電源が入らない。	主電源が入っていない。	本機後面の I/O (主電源) スイッチの I 側を押してください。
	本機の電源コードがはずれている。	電源コードをしっかり接続してください。
持続したプロジェクターの映像が映らない。	本機とプロジェクターが正しく接続されていない。	本機の OUTPUT A 端子とプロジェクターの INPUT A スロットの端子、本機の OUTPUT B 端子とプロジェクターの INPUT B スロットの端子を接続してください。
	本機と SMS 搭載のコントロール用コンピューターが正しく接続されていない。	イーサネットケーブルで正しく接続してください。
本機前面の READY インジケーターと ALARM インジケーターが点灯。	本機にトラブルが発生した。(スタンバイ時)	お買い上げ店またはソニーのサービス窓口にご相談ください。
本機前面の READY、PLAY、ALARM インジケーターすべてが点灯。	本機にトラブルが発生した。(再生中)	お買い上げ店またはソニーのサービス窓口にご相談ください。

本機の性能を保持するために

異常音について

本機の内部には温度上昇を防ぐためにファンが取り付けられており、電源を入れると多少音を生じます。しかし、異常音が発生した場合にはお買い上げ店にご相談ください。

お手入れについて

キャビネットやパネルの汚れは、柔らかい布で軽くふき取ってください。汚れがひどいときには、水でうすめた中性洗剤に柔らかい布をひたし、固くしぼってから汚れをふき取り、乾いた布で仕上げてください。なお、お手入れの際は必ず電源コードを本体から抜いてください。

結露について

結露とは、寒いところから急に暖かい場所へ持ち込んだとき、本体の内部に水滴がつくことです。結露が起きたときは、電源を入れたまま本機をそのまま約2時間放置してください。

アフターサービス

調子が悪いときはまずチェックを → この説明書をもう一度ご覧になってお調べください。

それでも具合の悪いときは → お買い上げ店にご相談ください。

仕様

再生

映像 JPEG2000、4096 × 2160 / 24p または 2048 × 1080 / 24p

音声 24 ビットリニア PCM (最大 16 チャンネル)

入出力

出力

OUTPUT A/B 端子

MDR 68 ピン

AUDIO OUTPUT AES/EBU 端子

BNC 型 (4)、AES3id-2001、8 チャンネル

D-sub 25 ピン (凹) (1)、AES3-2003、8 チャンネル (SMS ソフトにより 9 ~ 16 チャンネル出力可能) (ピン配列については「ピン配列」をご覧ください。)

入出力

ETHERNET 端子

100BASE-TX/1000BASE-T、Auto MDI、MDI-X 対応

RS-232C 1 端子

D-sub 9 ピン (凹) (メンテナンス用)

RS-232C 2 端子

D-sub 9 ピン (凹) (メンテナンス用)

SPARE 端子

D-sub 15 ピン (凹) (スペア用)

FIBRE CHANNEL 端子

ファイバーチャンネル、2 Gbps

入力

インプットボードスロット

LKRI-001 装着時：アナログ RGB/ コンポーネント、HDTV (YPbPr)、HDTV (GBR)

LKRI-002 装着時：HD-SDI (4:2:2) (SMPTE-292M)

LKRI-003 装着時：HD-SDI (4:4:4/4:2:2) (SMPTE-292M)、DC-SDI (4:4:4)

一般

電源 AC 100 ~ 240 V、50/60 Hz

消費電流 2.1 ~ 1.1 A

動作温度 5 ~ 35 °C

動作湿度 35 ~ 85%

保存温度 - 20 ~ +60 °C

最大外形寸法

424 × 221 × 455 mm (幅 / 高さ / 奥行き)
(突起部含まず)

質量 約 17.5 kg

付属品 IPM インプットボード (SR プロジェクター装着用)
(2)

PM-Link Cable (1-833-055-11、SONY) (2)

ラックアングル (2)

コネクターカバー (1)

取扱説明書 (1)

特約店様用設置説明書 (1)

取扱説明書 (CD-ROM) (1)

別売アクセサリ

アナログインプットボード LKRI-001

HD-SDI (4:2:2) インプットボード LKRI-002

HD-SDI (4:4:4/4:2:2) / DC-SDI (4:4:4) インプット
ボード LKRI-003

推奨品 RAID ディスク

ソニーの推奨品をお使いください。推奨品について詳しくは、お買い上げ店またはソニーのサービス窓口にお問い合わせください。

電源コード AC 電源コード (125 V、7 A、2.4 m)

(ソニー部品番号：1-791-041-1X)

この装置は、情報処理装置等電波障害自主規制協議会 (VCCI) の基準に基づくクラス A 情報技術装置です。この装置を家庭環境で使用すると電波妨害を引き起こすことがあります。この場合には使用者が適切な対策を講ずるよう要求されることがあります。

本機は「高調波電流規格 JIS C 61000-3-2 適合品」です。

本機の仕様および外観は改良のため予告なく変更することがありますが、ご了承ください。

お使いになる前に、必ず動作確認を行ってください。故障その他に伴う営業上の機会損失等は保証期間中および保証期間経過後にかかわらず、補償はいたしかねますのでご了承ください。

ピン配列

AUDIO OUTPUT (AES/EBU) 端子 (D-sub 25 ピン、凹)



ピン番号	機能	ピン番号	機能
1	GND	14	CH1/2+
2	CH1/2 -	15	GND
3	CH3/4+	16	CH3/4 -

ピン番号	機能	ピン番号	機能
4	GND	17	CH5/6+
5	CH5/6 -	18	GND
6	CH7/8+	19	CH7/8 -
7 ~ 13	NC	20 ~ 25	NC

WARNING

To reduce the risk of fire or electric shock, do not expose this apparatus to rain or moisture.

To avoid electrical shock, do not open the cabinet. Refer servicing to qualified personnel only.

WARNING**THIS APPARATUS MUST BE EARTHED.**

WARNING: THIS WARNING IS APPLICABLE FOR USA ONLY.

If used in USA, use the UL LISTED power cord specified below.

DO NOT USE ANY OTHER POWER CORD.

Plug Cap	Parallel blade with ground pin (NEMA 5-15P Configuration)
Cord	Type SJT, three 16 or 18 AWG wires
Length	Minimum 1.5m (4 ft .11in.), Less than 2.5 m (8 ft .3 in.)
Rating	Minimum 10A, 125V

Using this unit at a voltage other than 120V may require the use of a different line cord or attachment plug, or both. To reduce the risk of fire or electric shock, refer servicing to qualified service personnel.

WARNING: THIS WARNING IS APPLICABLE FOR OTHER COUNTRIES.

1. Use the approved Power Cord (3-core mains lead) / Appliance Connector / Plug with earthing-contacts that conforms to the safety regulations of each country if applicable.
2. Use the Power Cord (3-core mains lead) / Appliance Connector / Plug conforming to the proper ratings (Voltage, Ampere).

If you have questions on the use of the above Power Cord / Appliance Connector / Plug, please consult a qualified service personnel.

For the customers in the U.S.A.

This equipment has been tested and found to comply with the limits for a Class A digital device, pursuant to Part 15 of the FCC Rules. These limits are designed to provide reasonable protection against harmful interference when the equipment is operated in a commercial environment. This equipment generates, uses, and can radiate radio frequency energy and, if not installed and used in accordance with the instruction manual, may cause harmful interference to radio communications. Operation

of this equipment in a residential area is likely to cause harmful interference in which case the user will be required to correct the interference at his own expense.

You are cautioned that any changes or modifications not expressly approved in this manual could void your authority to operate this equipment.

All interface cables used to connect peripherals must be shielded in order to comply with the limits for a digital device pursuant to Subpart B of Part 15 of FCC Rules.

For the customers in Europe**WARNING**

This is a Class A product. In a domestic environment, this product may cause radio interference in which case the user may be required to take adequate measures.

Caution

Use of controls or adjustments or performance of procedures other than those specified herein may result in hazardous radiation exposure.

This Media Block is classified as a CLASS 1 LASER PRODUCT.

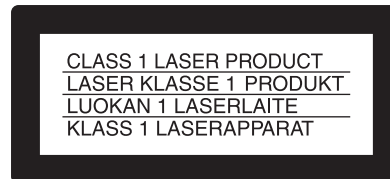
**Caution**

The use of optical instruments with this product will increase eye hazard.

Laser Diode Properties

Wave length: 850 nm
Emission duration: Continuous
Laser output power: 0.5 mW (max.)

Tekniska data för laserdiod

Våglängd: 850 nm
Emissionslängd: Kontinuerlig
Laserut effekt: 0,5 mW (max.)

Spesifikasjoner laserdiod

Bølgelengde: 850 nm
Strålingens varighet: Kontinuerlig
Laserens effekt: 0,5 mW (maks.)

Laserdiodin ominaisuudet

Aallon pituus: 850 nm
Välityksen kesto: Jatkuva
Laserlähdon teho: 0,5 mW (maks.)

For Customers in Taiwan only



廢電池請回收

AVERTISSEMENT

Afin de réduire les risques d'incendie ou d'électrocution, ne pas exposer cet appareil à la pluie ou à l'humidité.

Afin d'écartier tout risque d'électrocution, garder le coffret fermé. Ne confier l'entretien de l'appareil qu'à un personnel qualifié.

AVERTISSEMENT

CET APPAREIL DOIT ÊTRE RELIÉ À LA TERRE.

AVERTISSEMENT:

1. Utilisez un cordon d'alimentation (câble secteur à 3 fils)/fiche femelle/fiche mâle avec des contacts de mise la terre conformes à la réglementation de sécurité locale applicable.
2. Utilisez un cordon d'alimentation (câble secteur à 3 fils)/fiche femelle/fiche mâle avec des caractéristiques nominales (tension, ampérage) appropriées.

Pour toute question sur l'utilisation du cordon d'alimentation/fiche femelle/fiche mâle ci-dessus, consultez un technicien du service après-vente qualifié.

Pour les utilisateurs en Europe

AVERTISSEMENT

Il s'agit d'un produit de Classe A. Dans un environnement domestique, cet appareil peut provoquer des interférences radio, dans ce cas l'utilisateur peut être amené à prendre des mesures appropriées.

WARNUNG

Um die Gefahr von Bränden oder elektrischen Schlägen zu verringern, darf dieses Gerät nicht Regen oder Feuchtigkeit ausgesetzt werden.

Um einen elektrischen Schlag zu vermeiden, darf das Gehäuse nicht geöffnet werden. Überlassen Sie Wartungsarbeiten stets nur qualifiziertem Fachpersonal.

WARNUNG

DIESES GERÄT MUSS GEERDET WERDEN.

WARNUNG

1. Verwenden Sie ein geprüftes Netzkabel (3-adriges Stromkabel)/einen geprüften Geräteanschluss/einen geprüften Stecker mit Schutzkontakten entsprechend den Sicherheitsvorschriften, die im betreffenden Land gelten.
2. Verwenden Sie ein Netzkabel (3-adriges Stromkabel)/einen Geräteanschluss/einen Stecker mit den geeigneten Anschlusswerten (Volt, Ampere).

Wenn Sie Fragen zur Verwendung von Netzkabel/ Geräteanschluss/Stecker haben, wenden Sie sich bitte an qualifiziertes Kundendienstpersonal.

Für Kunden in Europa

Warnung

Dies ist eine Einrichtung, welche die Funk-Entstörung nach Klasse A besitzt. Diese Einrichtung kann im Wohnbereich Funkstörungen verursachen; in diesem Fall kann vom Betreiber verlangt werden, angemessene Maßnahmen durchzuführen und dafür anzukommen.

Eigenschaften der Laserdiode

Wellenlänge: 850 nm
Emissionsdauer. Ununterbrochen
Laser-Ausgangsleistung: 0,5 mW (max.)

GB

Table of Contents

Precautions	17
Features	17
Using the CD-ROM Manual	18
Preparations	18
Reading the CD-ROM Manual.....	18
Location and Function of Controls	18
Concerning the Indicators	20
Troubleshooting	21
Specifications	22
Notice Concerning Software Governed by the GNU GPL/LGPL	24

Precautions

On safety

- Operate the unit on 100 – 240 V AC, 50/60 Hz.
- Should any liquid or solid object fall into the cabinet, unplug the unit and have it checked by Qualified Sony Service Personnel before operating it further.
- Unplug the unit from the wall outlet or turn off the power switches on the front and rear of the unit if it is not to be used for several days.
- To disconnect the cord, pull it out by the plug. Never pull the cord itself.
- The wall outlet should be near the unit and easily accessible.
- The unit is not disconnected from the AC power source (mains) as long as it is connected to the wall outlet and the main power switch is turned on.
- Do not place your hand or objects near the ventilation holes. The air coming out is hot.
- Have at least two people carry and handle the unit, to avoid accidents or injury.
- Avoid using an extension cord with a low voltage limit, as it may cause short-circuiting and physical injury.
- To carry the unit, be sure to hold the bottom of the unit.
- Do not catch your finger between the unit and surface of the floor when moving the unit installed on the floor.
- Be careful not to catch your finger in the cooling fan.

On cleaning

To keep the cabinet looking new, periodically clean it with a soft cloth. Stubborn stains may be removed with a cloth lightly dampened with a mild detergent solution. Never use strong solvents, such as thinner, benzene, or abrasive cleansers, since these will damage the cabinet.

On repacking

Save the original shipping carton and packing material; they will come in handy if you ever have to ship your unit. For maximum protection, repack your unit as it was originally packed at the factory.

Features

The LMT-100 Media Block is a server located in a theater that offers the capability of digital cinema exhibition in combination with the SRX-R110 or SRX-R105 SR projector.

Compliant with DCI (Digital Cinema Initiative, LLC)

The LMT-100 supports the DCI specifications. The unit is available with playback of the 4K (4096 × 2160) or 2K (2048 × 1080) JPEG2000 video files included in DCP (Digital Cinema Package) of digital cinema distribution. The unit is also available with output of digital video signals to the connected SR projector.

Up to 16 channels digital audio playback

The LMT-100 plays back the audio files included in DCP and outputs up to 16 channels AES/EBU digital audio signals to the connected digital audio signal processor.

Supporting SMS (Screen Management System) application software

Connection with a computer with the SMS application software installed allows you to control operations of a digital cinema exhibition in a theater from the computer, or to perform a digital cinema test exhibition, etc.

Capable of exhibition of cinema sources other than digital cinema distribution

The LMT-100 is equipped with an input board slot. Installing an optional input board such as an HD-SDI or DC-SDI input board allows the unit to input the cinema sources from external equipment.

Note on software licenses

Before using this unit, read the notice concerning software licenses (pages 24 to 38) at the end of the Operating Instructions.

By using this unit, you will be deemed to have understood and agreed to the content of the notice.

Using the CD-ROM Manual

The supplied CD-ROM includes versions of the Operating Instructions for the LMT-100 in English, Japanese, French, German, Italian, Spanish, and Chinese in PDF format.

Preparations

The following program must be installed on your computer in order to read the Operating Instructions contained on the CD-ROM.

- Adobe Reader Version 6.0 or higher

Memo

If Adobe Reader is not installed, you can download it from the following URL:
<http://www.adobe.com/>

Adobe and Adobe Reader are trademarks of Adobe Systems Incorporated in the United States and/or other countries.

Reading the CD-ROM Manual

To read the Operating Instructions contained on the CD-ROM, do the following.

- 1 Insert the CD-ROM in your CD-ROM drive.

A cover page appears automatically in your browser. If it does not appear automatically in the browser, double-click on the index.htm file on the CD-ROM.
- 2 Select and click on the Operating Instructions that you want to read.

This opens the PDF file of the Operating Instructions.

Memo

The files may not be displayed properly, depending on the version of Acrobat Reader. In such a case, install the latest version you can download from the URL mentioned in "Preparations" above.

Note

If you have lost or damaged the CD-ROM, you can purchase a new one to replace it. Contact your Sony service representative.

Location and Function of Controls

Front

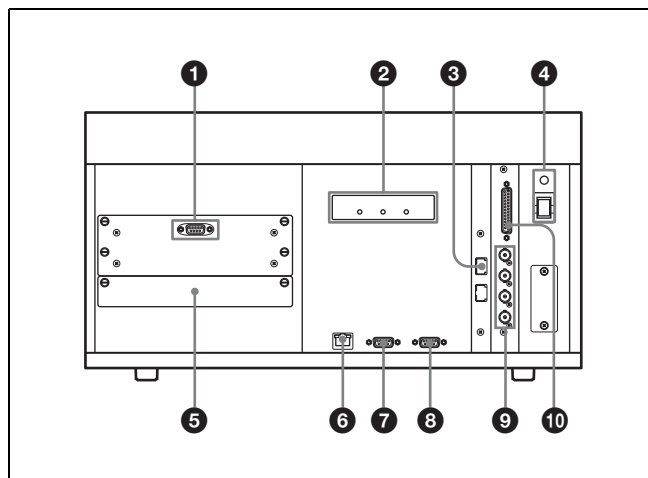

1 RS-232C 2 connector (D-sub 9-pin, female)

This is for maintenance use.

2 LED indicators

READY indicator: Flashes when both power switches on the rear and front panels of the unit are turned on. When the indicator lights steadily, the unit enters standby mode. When the unit is ready to be turned off after being shut down by a computer with the SMS software installed, the indicator flashes, then goes out. The unit can be turned off completely with the power switches on the front and rear panels.

PLAY indicator: Lights during playback of video and audio signals.

ALARM indicator: Lights when any trouble occurs on the unit.

For details on the indicators, see "Concerning the Indicators" on page 20 and "Troubleshooting" on page 21.

3 FIBRE CHANNEL connector

Connects to the RAID storage disk for DCP with a commercially available optical fibre cable. A dustproof cap is attached at the factory.

4 I/O (sub power) switch and I/O indicator

Pressing I on this switch when the I/O (main power) switch at the rear is on turns on the sub power of the unit. The I/O indicator lights in green, and the READY indicator on the front panel flashes and then lights steadily. Then, the unit enters standby mode.

To turn off the sub power, turn off the power on a computer with SMS installed, and when the READY indicator goes out, press .

5 Input board attachment part

Attach an optional input board such as the LKRI-001 to input the video signal from external equipment. For attachment, contact Qualified Sony Service Personnel.

6 ETHERNET connector (100BASE-TX/1000BASE-T)

Connects to a switching hub with a commercially available Ethernet cable to communicate with a computer used for importing the DCP or for controlling operations for a digital cinema exhibition via a network.

CAUTION

For safety, do not connect the connector for peripheral device wiring that might have excessive voltage to this port.

Follow the instructions for this port.

ATTENTION

Par mesure de sécurité, ne raccordez pas le connecteur pour le câblage de périphériques pouvant avoir une tension excessive à ce port. Suivez les instructions pour ce port.

ACHTUNG

Aus Sicherheitsgründen nicht mit einem Peripheriegerät-Anschluss verbinden, der zu starke Spannung für diese Buchse haben könnte. Folgen Sie den Anweisungen für diese Buchse.

7 RS-232C 1 connector (D-sub 9-pin, female)

This is for maintenance use.

8 SPARE connector (D-sub 15-pin, female)

This is a spare connector.

9 AUDIO OUTPUT (AES/EBU) connectors (BNC-type)

Connect to an audio signal processor. Output up to 8 channels digital audio signal.

10 AUDIO OUTPUT (AES/EBU) connector (D-sub 25-pin, female)

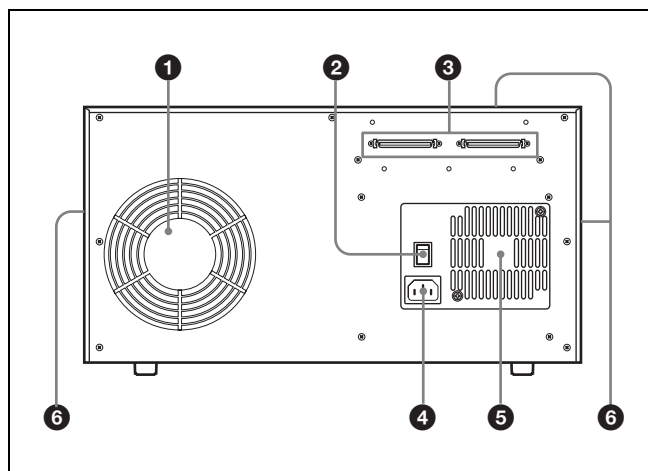

Connects to an audio signal processor. Outputs channel 1 to channel 8 audio signals at the factory. The output signals are the same as those output from the AUDIO OUTPUT connectors with BNC-type. Setting in a computer with the SMS software installed allows the unit to output channel 9 to channel 16 audio signals.

Rear panel



1 Ventilation holes (exhaust)

2 I/O (main power) switch

Turns on/off the main power. Press  to turn on the main power of the unit. To turn it off, turn off the  switch on the front panel, then press  on this switch.

3 OUTPUT A/B connectors (MDR 68-pin)

Connect to the INPUT connectors on the two input boards (supplied with this unit) attached to the SR projector using the two supplied connecting cables. Be sure to connect the OUTPUT A connector to the connector on the input board inserted into the INPUT A slot on the projector and the OUTPUT B connector to that on the input board inserted into the INPUT B slot.

4 AC IN (inlet)

Connect a commercially available three-wire power cord. For connection, contact Qualified Sony Service Personnel.

5 Ventilation holes (exhaust)

6 Ventilation holes (intake) (Top/left and right sides)

Concerning the Indicators

The LED indicators flash or light in the following conditions:

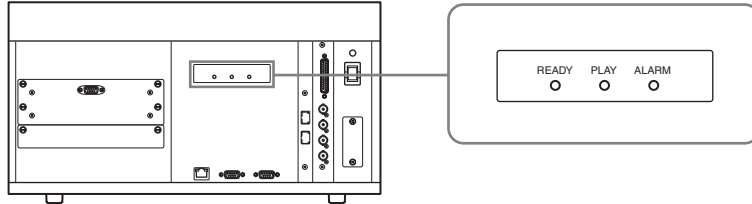

●: Lights ✨ : Flashes -: Goes out

READY	PLAY	ALARM	Meaning
✨	-	-	The unit warms up after the power switches on the rear and front panels are turned on.
●	-	-	The unit is in standby mode.
●	-	●	Trouble occurs while the unit is in standby mode.
●	●	-	The unit is in playback mode.
●	●	●	Trouble occurs while the unit is in playback mode.
✨	-	-	The unit is shut down by a computer with SMS installed.
-	-	-	The unit is ready to be turned off completely after being shut down by a computer. Turn off the I/O (sub power switch) on the front, and then the I/O (main power switch) at the rear.
✨	✨	✨	The IP address of the unit has been initialized.
✨	✨	-	A test pattern built into the unit is displayed on the screen.

Troubleshooting

If the unit appears to be operating erratically, try to diagnose and correct the problem using the following guide. If the problem still persists, consult with Qualified Sony Service Personnel.

Symptom	Cause	Remedy
Power is not turned on.	The main power is turned off.	Press I on the I/O (main power) switch at the rear.
	The AC power cord is disconnected.	Connect the AC power cord securely.
No picture on the connected projector	The unit is not correctly connected to the projector.	Connect the OUTPUT A connector to the connector on the INPUT A slot on the connected projector, and the OUTPUT B connector to that on the INPUT B slot.
	This unit and the computer with the SMS software installed are not connected correctly.	Connect them correctly using an Ethernet cable.
The READY and ALARM indicators on the front panel light.	Trouble occurs on this unit while it is in standby mode.	Consult with Qualified Sony Service Personnel.
The READY, PLAY and ALARM indicators on the front panel light.	Trouble occurs on this unit while it is in playback mode.	Consult with Qualified Sony Service Personnel.

Specifications

Playback format

Video	JPEG2000, 4096 × 2160 / 24p or 2048 × 1080 / 24p
Audio	24 bits liner PCM (up to 16 channels)

Output/Input

Output

OUTPUT A/B	MDR 68-pin
AUDIO OUTPUT AES/EBU	BNC-type (4), AES3id-2001, 8 channels D-sub 25-pin (female) (1), AES3-2003, 8 channels (16 channels available when controlled by a computer with SMS installed) (For details, see “Pin assignment.”)

Output/input

ETHERNET	100BASE-TX/1000BASE-T, Supports Auto MDI and MDI-X.
RS-232C 1	D-sub 9-pin (female) (for maintenance)
RS-232C 2	D-sub 9-pin (female) (for maintenance)
SPARE	D-sub 15-pin (female) (spare connector)
FIBRE CHANNEL	2 Gbps

Input

Input board slot	When the LKRI-001 is installed: Analog RGB/component, HDTV (YPbPr), HDTV (GBR) When the LKRI-002 is installed: HD-SDI (4:2:2) (SMPTE-292M) When the LKRI-003 is installed: HD-SDI (4:4:4/4:2:2) (SMPTE-292M), DC-SDI (4:4:4)
------------------	--

General

Power requirements	100 to 240 V AC, 50/60 Hz
Current consumption	2.1 to 1.1 A
Operating temperature	5°C to 35°C (41°F to 95°F)
Operating humidity	35 to 85% (no condensation)
Storage temperature	-20°C to +60°C (-4°F to +140°F)

Dimensions	424 × 221 × 455 mm (16 ³ / ₄ × 8 ³ / ₄ × 18 inches) (w/h/d) (not including the projection parts)
------------	--

Mass	Approx. 17.5 kg (38 lb 9 oz)
------	------------------------------

Supplied accessories	IPM input boards (for SR projector) (2) PM-Link Cables (1-833-055-11, SONY) (2) Angle brackets (2) Connector cover (1) Operating Instructions (1) Installation Manual for Dealers (1) Operating Instructions (CD-ROM) (1)
----------------------	---

Optional accessories	LKRI-001 analog input board LKRI-002 HD-SDI (4:2:2) input board LKRI-003 HD-SDI (4:4:4/4:2:2)/DC-SDI (4:4:4) input board
----------------------	--

Recommended accessory	RAID disk driver Use the products recommended by Sony. For details on the recommended products, contact Qualified Sony Service Personnel.
-----------------------	--

AC power cord	<ul style="list-style-type: none">For customers in the U.S.A. Power cord (125 V, 10 A, 2.4 m (7.9 feet)) (Part No. 1-551-812-3X)For customers in the European countries Power cord (250 V, 10 A, 2.5 m (8.2 feet)) (Part No. 1-782-929-1X)
---------------	---

Design and specifications are subject to change without notice.

Note

Always verify that the unit is operating properly before use. SONY WILL NOT BE LIABLE FOR DAMAGES OF ANY KIND INCLUDING, BUT NOT LIMITED TO, COMPENSATION OR REIMBURSEMENT ON ACCOUNT OF THE LOSS OF PRESENT OR PROSPECTIVE PROFITS DUE TO FAILURE OF THIS UNIT, EITHER DURING THE WARRANTY PERIOD OR AFTER EXPIRATION OF THE WARRANTY, OR FOR ANY OTHER REASON WHATSOEVER.

Pin assignment

AUDIO OUTPUT (AES/EBU) (D-sub 25-pin, female)



Pin No.	Function	Pin No.	Function
1	GND	14	CH1/2+
2	CH1/2-	15	GND
3	CH3/4+	16	CH3/4-
4	GND	17	CH5/6+
5	CH5/6-	18	GND
6	CH7/8+	19	CH7/8-
7 - 13	NC	20 - 25	NC

GNU GPL/LGPL 適用ソフトウェアに関するお知らせ

本製品には、以下の GNU General Public License（以下「GPL」とします）または GNU Lesser General Public License（以下「LGPL」とします）の適用を受けるソフトウェアが含まれております。お客様は添付の GPL/LGPL の条件に従い、これらのソフトウェアのソースコードの入手、改変、再配布の権利があることをお知らせいたします。

Notice Concerning Software Governed by the GNU GPL/LGPL

This product includes software to which the GNU General Public License (“GPL”) or GNU Lesser General Public License (“LGPL”) applies. Under the terms of the GPL/LGPL, of which a copy is attached, you have the right to obtain, modify, and distribute copies of the source code of this software.

パッケージリスト

Package list

binutils-2.14
busybox-1.00
e2fsprogs-1.35
ethtools-3
gcc-3.3.2
gdb-6.1
glibc-2.3.2
grep-2.2
libpwdb-0.54preD
linux-2.4.25
Linux-PAM-0.72
logrotate-3.7
modutils-2.4.26
ncurses-5.2
net-tools-1.60
setserial-2.17
sh-utils-1.16
sysklogd-1.4.1
textutils-1.22
tinylogin-1.4
util-linux-2.12q
xfsdump-2.2.33
xfsprogs-2.5.6
vsftpd-1.2.1
less-358

ソースコードの入手方法については、弊社サービスにお問い合わせください。

To Obtain information on the source code and/or the source code for this software. Consult your nearest Sony Service.

The GNU General Public License (GPL)

Version 2, June 1991

Copyright (C) 1989, 1991 Free Software Foundation, Inc.
59 Temple Place, Suite 330, Boston, MA 02111-1307 USA
Everyone is permitted to copy and distribute verbatim copies
of this license document, but changing it is not allowed.

Preamble

The licenses for most software are designed to take away your freedom to share and change it. By contrast, the GNU General Public License is intended to guarantee your freedom to share and change free software—to make sure the software is free for all its users. This General Public License applies to most of the Free Software Foundation's software and to any other program whose authors commit to using it. (Some other Free Software Foundation software is covered by the GNU Library General Public License instead.) You can apply it to your programs, too.

When we speak of free software, we are referring to freedom, not price. Our General Public Licenses are designed to make sure that you have the freedom to distribute copies of free software (and charge for this service if you wish), that you receive source code or can get it if you want it, that you can change the software or use pieces of it in new free programs; and that you know you can do these things.

To protect your rights, we need to make restrictions that forbid anyone to deny you these rights or to ask you to surrender the rights. These restrictions translate to certain responsibilities for you if you distribute copies of the software, or if you modify it.

For example, if you distribute copies of such a program, whether gratis or for a fee, you must give the recipients all the rights that you have. You must make sure that they, too, receive or can get the source code. And you must show them these terms so they know their rights.

We protect your rights with two steps: (1) copyright the software, and (2) offer you this license which gives you legal permission to copy, distribute and/or modify the software.

Also, for each author's protection and ours, we want to make certain that everyone understands that there is no warranty for this free software. If the software is modified by someone else and passed on, we want its recipients to know that what they have is not the original, so that any problems introduced by others will not reflect on the original authors' reputations.

Finally, any free program is threatened constantly by software patents. We wish to avoid the danger that redistributors of a free program will individually obtain patent licenses, in effect making the program proprietary. To prevent this, we have made it clear that any patent must be licensed for everyone's free use or not licensed at all.

The precise terms and conditions for copying, distribution and modification follow.

TERMS AND CONDITIONS FOR COPYING, DISTRIBUTION AND MODIFICATION

0. This License applies to any program or other work which contains a notice placed by the copyright holder saying it may be distributed under the terms of this General Public License. The "Program", below, refers to any such program or work, and a "work based on the Program" means either the Program or any derivative work under copyright law: that is to say, a work containing the Program or a portion of it, either verbatim or with modifications and/or translated into another language. (Hereinafter, translation is included without limitation in the term "modification".) Each licensee is addressed as "you".

Activities other than copying, distribution and modification are not covered by this License; they are outside its scope. The act of running the Program is not restricted, and the output from the Program is covered only if its contents constitute a work based on the Program (independent of having been made by running the Program). Whether that is true depends on what the Program does.

1. You may copy and distribute verbatim copies of the Program's source code as you receive it, in any medium, provided that you conspicuously and appropriately publish on each copy an appropriate copyright notice and disclaimer of warranty; keep intact all the notices that refer to this License and to the absence of any warranty; and give any other recipients of the Program a copy of this License along with the Program.

You may charge a fee for the physical act of transferring a copy, and you may at your option offer warranty protection in exchange for a fee.

2. You may modify your copy or copies of the Program or any portion of it, thus forming a work based on the Program, and copy and distribute such modifications or work under the terms of Section 1 above, provided that you also meet all of these conditions:

- a) You must cause the modified files to carry prominent notices stating that you changed the files and the date of any change.

- b) You must cause any work that you distribute or publish, that in whole or in part contains or is derived from the Program or any part thereof, to be licensed as a whole at no charge to all third parties under the terms of this License.
- c) If the modified program normally reads commands interactively when run, you must cause it, when started running for such interactive use in the most ordinary way, to print or display an announcement including an appropriate copyright notice and a notice that there is no warranty (or else, saying that you provide a warranty) and that users may redistribute the program under these conditions, and telling the user how to view a copy of this License. (Exception: if the Program itself is interactive but does not normally print such an announcement, your work based on the Program is not required to print an announcement.)

These requirements apply to the modified work as a whole. If identifiable sections of that work are not derived from the Program, and can be reasonably considered independent and separate works in themselves, then this License, and its terms, do not apply to those sections when you distribute them as separate works. But when you distribute the same sections as part of a whole which is a work based on the Program, the distribution of the whole must be on the terms of this License, whose permissions for other licensees extend to the entire whole, and thus to each and every part regardless of who wrote it.

Thus, it is not the intent of this section to claim rights or contest your rights to work written entirely by you; rather, the intent is to exercise the right to control the distribution of derivative or collective works based on the Program.

In addition, mere aggregation of another work not based on the Program with the Program (or with a work based on the Program) on a volume of a storage or distribution medium does not bring the other work under the scope of this License.

- 3. You may copy and distribute the Program (or a work based on it, under Section 2) in object code or executable form under the terms of Sections 1 and 2 above provided that you also do one of the following:
 - a) Accompany it with the complete corresponding machine-readable source code, which must be distributed under the terms of Sections 1 and 2 above on a medium customarily used for software interchange; or,
 - b) Accompany it with a written offer, valid for at least three years, to give any third party, for a charge no more than your cost of physically performing source distribution, a complete machine-readable copy of the corresponding source code, to be distributed under the terms of Sections 1 and 2 above on a medium customarily used for software interchange; or,
 - c) Accompany it with the information you received as to the offer to distribute corresponding source code. (This alternative is allowed only for noncommercial distribution and only if you received the program in object code or executable form with such an offer, in accord with Subsection b above.)

The source code for a work means the preferred form of the work for making modifications to it. For an executable work, complete source code means all the source code for all modules it contains, plus any associated interface definition files, plus the scripts used to control compilation and installation of the executable. However, as a special exception, the source code distributed need not include anything that is normally distributed (in either source or binary form) with the major components (compiler, kernel, and so on) of the operating system on which the executable runs, unless that component itself accompanies the executable.

If distribution of executable or object code is made by offering access to copy from a designated place, then offering equivalent access to copy the source code from the same place counts as distribution of the source code, even though third parties are not compelled to copy the source along with the object code.

- 4. You may not copy, modify, sublicense, or distribute the Program except as expressly provided under this License. Any attempt otherwise to copy, modify, sublicense or distribute the Program is void, and will automatically terminate your rights under this License. However, parties who have received copies, or rights, from you under this License will not have their licenses terminated so long as such parties remain in full compliance.
- 5. You are not required to accept this License, since you have not signed it. However, nothing else grants you permission to modify or distribute the Program or its derivative works. These actions are prohibited by law if you do not accept this License. Therefore, by modifying or distributing the Program (or any work based on the Program), you indicate your acceptance of this License to do so, and all its terms and conditions for copying, distributing or modifying the Program or works based on it.
- 6. Each time you redistribute the Program (or any work based on the Program), the recipient automatically receives a license from the original licensor to copy, distribute or modify the Program subject to these terms and conditions. You may not impose any further restrictions on the recipients' exercise of the rights granted herein. You are not responsible for enforcing compliance by third parties to this License.
- 7. If, as a consequence of a court judgment or allegation of patent infringement or for any other reason (not limited to patent issues), conditions are imposed on you (whether by court order, agreement or otherwise) that contradict the conditions of this License, they do not

excuse you from the conditions of this License. If you cannot distribute so as to satisfy simultaneously your obligations under this License and any other pertinent obligations, then as a consequence you may not distribute the Program at all. For example, if a patent license would not permit royalty-free redistribution of the Program by all those who receive copies directly or indirectly through you, then the only way you could satisfy both it and this License would be to refrain entirely from distribution of the Program.

If any portion of this section is held invalid or unenforceable under any particular circumstance, the balance of the section is intended to apply and the section as a whole is intended to apply in other circumstances.

It is not the purpose of this section to induce you to infringe any patents or other property right claims or to contest validity of any such claims; this section has the sole purpose of protecting the integrity of the free software distribution system, which is implemented by public license practices. Many people have made generous contributions to the wide range of software distributed through that system in reliance on consistent application of that system; it is up to the author/donor to decide if he or she is willing to distribute software through any other system and a licensee cannot impose that choice.

This section is intended to make thoroughly clear what is believed to be a consequence of the rest of this License.

8. If the distribution and/or use of the Program is restricted in certain countries either by patents or by copyrighted interfaces, the original copyright holder who places the Program under this License may add an explicit geographical distribution limitation excluding those countries, so that distribution is permitted only in or among countries not thus excluded. In such case, this License incorporates the limitation as if written in the body of this License.
9. The Free Software Foundation may publish revised and/or new versions of the General Public License from time to time. Such new versions will be similar in spirit to the present version, but may differ in detail to address new problems or concerns.

Each version is given a distinguishing version number. If the Program specifies a version number of this License which applies to it and “any later version”, you have the option of following the terms and conditions either of that version or of any later version published by the Free Software Foundation. If the Program does not specify a version number of this License, you may choose any version ever published by the Free Software Foundation.

10. If you wish to incorporate parts of the Program into other free programs whose distribution conditions are different, write to the author to ask for permission. For software which is copyrighted by the Free Software Foundation, write to the Free Software Foundation; we sometimes make exceptions for this. Our decision will be guided by the two goals of preserving the free status of all derivatives of our free software and of promoting the sharing and reuse of software generally.

NO WARRANTY

11. BECAUSE THE PROGRAM IS LICENSED FREE OF CHARGE, THERE IS NO WARRANTY FOR THE PROGRAM, TO THE EXTENT PERMITTED BY APPLICABLE LAW. EXCEPT WHEN OTHERWISE STATED IN WRITING THE COPYRIGHT HOLDERS AND/OR OTHER PARTIES PROVIDE THE PROGRAM “AS IS” WITHOUT WARRANTY OF ANY KIND, EITHER EXPRESSED OR IMPLIED, INCLUDING, BUT NOT LIMITED TO, THE IMPLIED WARRANTIES OF MERCHANTABILITY AND FITNESS FOR A PARTICULAR PURPOSE. THE ENTIRE RISK AS TO THE QUALITY AND PERFORMANCE OF THE PROGRAM IS WITH YOU. SHOULD THE PROGRAM PROVE DEFECTIVE, YOU ASSUME THE COST OF ALL NECESSARY SERVICING, REPAIR OR CORRECTION.
12. IN NO EVENT UNLESS REQUIRED BY APPLICABLE LAW OR AGREED TO IN WRITING WILL ANY COPYRIGHT HOLDER, OR ANY OTHER PARTY WHO MAY MODIFY AND/OR REDISTRIBUTE THE PROGRAM AS PERMITTED ABOVE, BE LIABLE TO YOU FOR DAMAGES, INCLUDING ANY GENERAL, SPECIAL, INCIDENTAL OR CONSEQUENTIAL DAMAGES ARISING OUT OF THE USE OR INABILITY TO USE THE PROGRAM (INCLUDING BUT NOT LIMITED TO LOSS OF DATA OR DATA BEING RENDERED INACCURATE OR LOSSES SUSTAINED BY YOU OR THIRD PARTIES OR A FAILURE OF THE PROGRAM TO OPERATE WITH ANY OTHER PROGRAMS), EVEN IF SUCH HOLDER OR OTHER PARTY HAS BEEN ADVISED OF THE POSSIBILITY OF SUCH DAMAGES.

END OF TERMS AND CONDITIONS

How to Apply These Terms to Your New Programs

If you develop a new program, and you want it to be of the greatest possible use to the public, the best way to achieve this is to make it free software which everyone can redistribute and change under these terms.

To do so, attach the following notices to the program. It is safest to attach them to the start of each source file to most effectively convey the exclusion of warranty; and each file should have at least the “copyright” line and a pointer to where the full notice is found.

One line to give the program’s name and a brief idea of what it does.

Copyright (C) <year> <name of author>

This program is free software; you can redistribute it and/or modify it under the terms of the GNU General Public License as published by the Free Software Foundation; either version 2 of the License, or (at your option) any later version.

This program is distributed in the hope that it will be useful, but WITHOUT ANY WARRANTY; without even the implied warranty of MERCHANTABILITY or FITNESS FOR A PARTICULAR PURPOSE. See the GNU General Public License for more details.

You should have received a copy of the GNU General Public License along with this program; if not, write to the Free Software Foundation, Inc., 59 Temple Place, Suite 330, Boston, MA 02111-1307 USA

Also add information on how to contact you by electronic and paper mail.

If the program is interactive, make it output a short notice like this when it starts in an interactive mode:

Gnomovision version 69, Copyright (C) year name of author Gnomovision comes with ABSOLUTELY NO WARRANTY; for details type 'show w'. This is free software, and you are welcome to redistribute it under certain conditions; type 'show c' for details.

The hypothetical commands 'show w' and 'show c' should show the appropriate parts of the General Public License. Of course, the commands you use may be called something other than 'show w' and 'show c'; they could even be mouse-clicks or menu items--whatever suits your program.

You should also get your employer (if you work as a programmer) or your school, if any, to sign a "copyright disclaimer" for the program, if necessary. Here is a sample; alter the names:

Yoyodyne, Inc., hereby disclaims all copyright interest in the program 'Gnomovision' (which makes passes at compilers) written by James Hacker.

signature of Ty Coon, 1 April 1989
Ty Coon, President of Vice

This General Public License does not permit incorporating your program into proprietary programs. If your program is a subroutine library, you may consider it more useful to permit linking proprietary applications with the library. If this is what you want to do, use the GNU Library General Public License instead of this License.

GNU Lesser General Public License

Version 2.1, February 1999

Copyright (C) 1991, 1999 Free Software Foundation, Inc.
59 Temple Place, Suite 330, Boston, MA 02111-1307 USA

Everyone is permitted to copy and distribute verbatim copies of this license document, but changing it is not allowed.

[This is the first released version of the Lesser GPL. It also counts as the successor of the GNU Library Public License, version 2, hence the version number 2.1.]

Preamble

The licenses for most software are designed to take away your freedom to share and change it. By contrast, the GNU General Public Licenses are intended to guarantee your freedom to share and change free software--to make sure the software is free for all its users.

This license, the Lesser General Public License, applies to some specially designated software packages--typically libraries--of the Free Software Foundation and other authors who decide to use it. You can use it too, but we suggest you first think carefully about whether this license or the ordinary General Public License is the better strategy to use in any particular case, based on the explanations below.

When we speak of free software, we are referring to freedom of use, not price. Our General Public Licenses are designed to make sure that you have the freedom to distribute copies of free software (and charge for this service if you wish); that you receive source code or can get it if you want it; that you can change the software and use pieces of it in new free programs; and that you are informed that you can do these things.

To protect your rights, we need to make restrictions that forbid distributors to deny you these rights or to ask you to surrender these rights. These restrictions translate to certain responsibilities for you if you distribute copies of the library or if you modify it.

For example, if you distribute copies of the library, whether gratis or for a fee, you must give the recipients all the rights that we gave you. You must make sure that they, too, receive or can get the source code. If you link other code with the library, you must provide complete object files to the recipients, so that they can relink them with the library after making changes to the library and recompiling it. And you must show them these terms so they know their rights.

We protect your rights with a two-step method: (1) we copyright the library, and (2) we offer you this license, which gives you legal permission to copy, distribute and/or modify the library.

To protect each distributor, we want to make it very clear that there is no warranty for the free library. Also, if the library is modified by someone else and passed on, the recipients should know that what they have is not the original version, so that the original author's reputation will not be affected by problems that might be introduced by others.

Finally, software patents pose a constant threat to the existence of any free program. We wish to make sure that a company cannot effectively restrict the users of a free program by obtaining a restrictive license from a patent holder. Therefore, we insist that any patent license obtained for a version of the library must be consistent with the full freedom of use specified in this license.

Most GNU software, including some libraries, is covered by the ordinary GNU General Public License. This license, the GNU Lesser General Public License, applies to certain designated libraries, and is quite different from the ordinary General Public License. We use this license for certain libraries in order to permit linking those libraries into non-free programs.

When a program is linked with a library, whether statically or using a shared library, the combination of the two is legally speaking a combined work, a derivative of the original library. The ordinary General Public License therefore permits such linking only if the entire combination fits its criteria of freedom. The Lesser General Public License permits more lax criteria for linking other code with the library.

We call this license the “Lesser” General Public License because it does Less to protect the user’s freedom than the ordinary General Public License. It also provides other free software developers Less of an advantage over competing non-free programs. These disadvantages are the reason we use the ordinary General Public License for many libraries. However, the Lesser license provides advantages in certain special circumstances.

For example, on rare occasions, there may be a special need to encourage the widest possible use of a certain library, so that it becomes a de-facto standard. To achieve this, non-free programs must be allowed to use the library. A more frequent case is that a free library does the same job as widely used non-free libraries. In this case, there is little to gain by limiting the free library to free software only, so we use the Lesser General Public License.

In other cases, permission to use a particular library in non-free programs enables a greater number of people to use a large body of free software. For example, permission to use the GNU C Library in non-free programs enables many more people to use the whole GNU operating system, as well as its variant, the GNU/Linux operating system.

Although the Lesser General Public License is Less protective of the users’ freedom, it does ensure that the user of a program that is linked with the Library has the freedom and the wherewithal to run that program using a modified version of the Library.

The precise terms and conditions for copying, distribution and modification follow. Pay close attention to the difference between a “work based on the library” and a “work that uses the library”. The former contains code derived from the library, whereas the latter must be combined with the library in order to run.

TERMS AND CONDITIONS FOR COPYING, DISTRIBUTION AND MODIFICATION

0. This License Agreement applies to any software library or other program which contains a notice placed by the copyright holder or other authorized party saying it may be distributed under the terms of this Lesser General Public License (also called “this License”). Each licensee is addressed as “you”.

A “library” means a collection of software functions and/or data prepared so as to be conveniently linked with application programs (which use some of those functions and data) to form executables.

The “Library”, below, refers to any such software library or work which has been distributed under these terms. A “work based on the Library” means either the Library or any derivative work under copyright law: that is to say, a work containing the Library or a portion of it, either verbatim or with modifications and/or translated straightforwardly into another language. (Hereinafter, translation is included without limitation in the term “modification”.)

“Source code” for a work means the preferred form of the work for making modifications to it. For a library, complete source code means all the source code for all modules it contains, plus any associated interface definition files, plus the scripts used to control compilation and installation of the library.

Activities other than copying, distribution and modification are not covered by this License; they are outside its scope. The act of running a program using the Library is not restricted, and output from such a program is covered only if its contents constitute a work based on the Library (independent of the use of the Library in a tool for writing it). Whether that is true depends on what the Library does and what the program that uses the Library does.

1. You may copy and distribute verbatim copies of the Library's complete source code as you receive it, in any medium, provided that you conspicuously and appropriately publish on each copy an appropriate copyright notice and disclaimer of warranty; keep intact all the notices that refer to this License and to the absence of any warranty; and distribute a copy of this License along with the Library.

You may charge a fee for the physical act of transferring a copy, and you may at your option offer warranty protection in exchange for a fee.

2. You may modify your copy or copies of the Library or any portion of it, thus forming a work based on the Library, and copy and distribute such modifications or work under the terms of Section 1 above, provided that you also meet all of these conditions:
 - a) The modified work must itself be a software library.
 - b) You must cause the files modified to carry prominent notices stating that you changed the files and the date of any change.
 - c) You must cause the whole of the work to be licensed at no charge to all third parties under the terms of this License.
 - d) If a facility in the modified Library refers to a function or a table of data to be supplied by an application program that uses the facility, other than as an argument passed when the facility is invoked, then you must make a good faith effort to ensure that, in the event an application does not supply such function or table, the facility still operates, and performs whatever part of its purpose remains meaningful.

(For example, a function in a library to compute square roots has a purpose that is entirely well-defined independent of the application. Therefore, Subsection 2d requires that any application-supplied function or table used by this function must be optional: if the application does not supply it, the square root function must still compute square roots.)

These requirements apply to the modified work as a whole. If identifiable sections of that work are not derived from the Library, and can be reasonably considered independent and separate works in themselves, then this License, and its terms, do not apply to those sections when you distribute them as separate works. But when you distribute the same sections as part of a whole which is a work based on the Library, the distribution of the whole must be on the terms of this License, whose permissions for other licensees extend to the entire whole, and thus to each and every part regardless of who wrote it.

Thus, it is not the intent of this section to claim rights or contest your rights to work written entirely by you; rather, the intent is to exercise the right to control the distribution of derivative or collective works based on the Library.

In addition, mere aggregation of another work not based on the Library with the Library (or with a work based on the Library) on a volume of a storage or distribution medium does not bring the other work under the scope of this License.

3. You may opt to apply the terms of the ordinary GNU General Public License instead of this License to a given copy of the Library. To do this, you must alter all the notices that refer to this License, so that they refer to the ordinary GNU General Public License, version 2, instead of to this License. (If a newer version than version 2 of the ordinary GNU General Public License has appeared, then you can specify that version instead if you wish.) Do not make any other change in these notices.

Once this change is made in a given copy, it is irreversible for that copy, so the ordinary GNU General Public License applies to all subsequent copies and derivative works made from that copy.

This option is useful when you wish to copy part of the code of the Library into a program that is not a library.

4. You may copy and distribute the Library (or a portion or derivative of it, under Section 2) in object code or executable form under the terms of Sections 1 and 2 above provided that you accompany it with the complete corresponding machine-readable source code, which must be distributed under the terms of Sections 1 and 2 above on a medium customarily used for software interchange.

If distribution of object code is made by offering access to copy from a designated place, then offering equivalent access to copy the source code from the same place satisfies the requirement to distribute the source code, even though third parties are not compelled to copy the source along with the object code.

5. A program that contains no derivative of any portion of the Library, but is designed to work with the Library by being compiled or linked with it, is called a “work that uses the Library”. Such a work, in isolation, is not a derivative work of the Library, and therefore falls outside the scope of this License.

However, linking a “work that uses the Library” with the Library creates an executable that is a derivative of the Library (because it contains portions of the Library), rather than a “work that uses the library”. The executable is therefore covered by this License. Section 6 states terms for distribution of such executables.

When a “work that uses the Library” uses material from a header file that is part of the Library, the object code for the work may be a derivative work of the Library even though the source code is not. Whether this is true is especially significant if the work can be linked without the Library, or if the work is itself a library. The threshold for this to be true is not precisely defined by law.

If such an object file uses only numerical parameters, data structure layouts and accessors, and small macros and small inline functions (ten lines or less in length), then the use of the object file is unrestricted, regardless of whether it is legally a derivative work. (Executables containing this object code plus portions of the Library will still fall under Section 6.)

Otherwise, if the work is a derivative of the Library, you may distribute the object code for the work under the terms of Section 6. Any executables containing that work also fall under Section 6, whether or not they are linked directly with the Library itself.

6. As an exception to the Sections above, you may also combine or link a “work that uses the Library” with the Library to produce a work containing portions of the Library, and distribute that work under terms of your choice, provided that the terms permit modification of the work for the customer's own use and reverse engineering for debugging such modifications.

You must give prominent notice with each copy of the work that the Library is used in it and that the Library and its use are covered by this License. You must supply a copy of this License. If the work during execution displays copyright notices, you must include the copyright notice for the Library among them, as well as a reference directing the user to the copy of this License. Also, you must do one of these things:

- a) Accompany the work with the complete corresponding machine-readable source code for the Library including whatever changes were used in the work (which must be distributed under Sections 1 and 2 above); and, if the work is an executable linked with the Library, with the complete machine-readable “work that uses the Library”, as object code and/or source code, so that the user can modify the Library and then relink to produce a modified executable containing the modified Library. (It is understood that the user who changes the contents of definitions files in the Library will not necessarily be able to recompile the application to use the modified definitions.)
- b) Use a suitable shared library mechanism for linking with the Library. A suitable mechanism is one that (1) uses at run time a copy of the library already present on the user's computer system, rather than copying library functions into the executable, and (2) will operate properly with a modified version of the library, if the user installs one, as long as the modified version is interface-compatible with the version that the work was made with.
- c) Accompany the work with a written offer, valid for at least three years, to give the same user the materials specified in Subsection 6a, above, for a charge no more than the cost of performing this distribution.
- d) If distribution of the work is made by offering access to copy from a designated place, offer equivalent access to copy the above specified materials from the same place.
- e) Verify that the user has already received a copy of these materials or that you have already sent this user a copy.

For an executable, the required form of the “work that uses the Library” must include any data and utility programs needed for reproducing the executable from it. However, as a special exception, the materials to be distributed need not include anything that is normally distributed (in either source or binary form) with the major components (compiler, kernel, and so on) of the operating system on which the executable runs, unless that component itself accompanies the executable.

It may happen that this requirement contradicts the license restrictions of other proprietary libraries that do not normally accompany the operating system. Such a contradiction means you cannot use both them and the Library together in an executable that you distribute.

7. You may place library facilities that are a work based on the Library side-by-side in a single library together with other library facilities not covered by this License, and distribute such a combined library, provided that the separate distribution of the work based on the Library and of the other library facilities is otherwise permitted, and provided that you do these two things:
 - a) Accompany the combined library with a copy of the same work based on the Library, uncombined with any other library facilities. This must be distributed under the terms of the Sections above.

- b) Give prominent notice with the combined library of the fact that part of it is a work based on the Library, and explaining where to find the accompanying uncombined form of the same work.
8. You may not copy, modify, sublicense, link with, or distribute the Library except as expressly provided under this License. Any attempt otherwise to copy, modify, sublicense, link with, or distribute the Library is void, and will automatically terminate your rights under this License. However, parties who have received copies, or rights, from you under this License will not have their licenses terminated so long as such parties remain in full compliance.
9. You are not required to accept this License, since you have not signed it. However, nothing else grants you permission to modify or distribute the Library or its derivative works. These actions are prohibited by law if you do not accept this License. Therefore, by modifying or distributing the Library (or any work based on the Library), you indicate your acceptance of this License to do so, and all its terms and conditions for copying, distributing or modifying the Library or works based on it.
10. Each time you redistribute the Library (or any work based on the Library), the recipient automatically receives a license from the original licensor to copy, distribute, link with or modify the Library subject to these terms and conditions. You may not impose any further restrictions on the recipients' exercise of the rights granted herein. You are not responsible for enforcing compliance by third parties with this License.
11. If, as a consequence of a court judgment or allegation of patent infringement or for any other reason (not limited to patent issues), conditions are imposed on you (whether by court order, agreement or otherwise) that contradict the conditions of this License, they do not excuse you from the conditions of this License. If you cannot distribute so as to satisfy simultaneously your obligations under this License and any other pertinent obligations, then as a consequence you may not distribute the Library at all. For example, if a patent license would not permit royalty-free redistribution of the Library by all those who receive copies directly or indirectly through you, then the only way you could satisfy both it and this License would be to refrain entirely from distribution of the Library.

If any portion of this section is held invalid or unenforceable under any particular circumstance, the balance of the section is intended to apply, and the section as a whole is intended to apply in other circumstances.

It is not the purpose of this section to induce you to infringe any patents or other property right claims or to contest validity of any such claims; this section has the sole purpose of protecting the integrity of the free software distribution system which is implemented by public license practices. Many people have made generous contributions to the wide range of software distributed through that system in reliance on consistent application of that system; it is up to the author/donor to decide if he or she is willing to distribute software through any other system and a licensee cannot impose that choice.

This section is intended to make thoroughly clear what is believed to be a consequence of the rest of this License.

12. If the distribution and/or use of the Library is restricted in certain countries either by patents or by copyrighted interfaces, the original copyright holder who places the Library under this License may add an explicit geographical distribution limitation excluding those countries, so that distribution is permitted only in or among countries not thus excluded. In such case, this License incorporates the limitation as if written in the body of this License.
13. The Free Software Foundation may publish revised and/or new versions of the Lesser General Public License from time to time. Such new versions will be similar in spirit to the present version, but may differ in detail to address new problems or concerns.

Each version is given a distinguishing version number. If the Library specifies a version number of this License which applies to it and “any later version”, you have the option of following the terms and conditions either of that version or of any later version published by the Free Software Foundation. If the Library does not specify a license version number, you may choose any version ever published by the Free Software Foundation.

14. If you wish to incorporate parts of the Library into other free programs whose distribution conditions are incompatible with these, write to the author to ask for permission. For software which is copyrighted by the Free Software Foundation, write to the Free Software Foundation; we sometimes make exceptions for this. Our decision will be guided by the two goals of preserving the free status of all derivatives of our free software and of promoting the sharing and reuse of software generally.

NO WARRANTY

15. BECAUSE THE LIBRARY IS LICENSED FREE OF CHARGE, THERE IS NO WARRANTY FOR THE LIBRARY, TO THE EXTENT PERMITTED BY APPLICABLE LAW. EXCEPT WHEN OTHERWISE STATED IN WRITING THE COPYRIGHT HOLDERS AND/OR OTHER PARTIES PROVIDE THE LIBRARY “AS IS” WITHOUT WARRANTY OF ANY KIND, EITHER EXPRESSED OR IMPLIED, INCLUDING, BUT NOT LIMITED TO, THE IMPLIED WARRANTIES OF MERCHANTABILITY AND FITNESS FOR A PARTICULAR PURPOSE. THE ENTIRE RISK AS TO THE QUALITY AND PERFORMANCE OF THE

LIBRARY IS WITH YOU. SHOULD THE LIBRARY PROVE DEFECTIVE, YOU ASSUME THE COST OF ALL NECESSARY SERVICING, REPAIR OR CORRECTION.

16. IN NO EVENT UNLESS REQUIRED BY APPLICABLE LAW OR AGREED TO IN WRITING WILL ANY COPYRIGHT HOLDER, OR ANY OTHER PARTY WHO MAY MODIFY AND/OR REDISTRIBUTE THE LIBRARY AS PERMITTED ABOVE, BE LIABLE TO YOU FOR DAMAGES, INCLUDING ANY GENERAL, SPECIAL, INCIDENTAL OR CONSEQUENTIAL DAMAGES ARISING OUT OF THE USE OR INABILITY TO USE THE LIBRARY (INCLUDING BUT NOT LIMITED TO LOSS OF DATA OR DATA BEING RENDERED INACCURATE OR LOSSES SUSTAINED BY YOU OR THIRD PARTIES OR A FAILURE OF THE LIBRARY TO OPERATE WITH ANY OTHER SOFTWARE), EVEN IF SUCH HOLDER OR OTHER PARTY HAS BEEN ADVISED OF THE POSSIBILITY OF SUCH DAMAGES.

END OF TERMS AND CONDITIONS

How to Apply These Terms to Your New Libraries

If you develop a new library, and you want it to be of the greatest possible use to the public, we recommend making it free software that everyone can redistribute and change. You can do so by permitting redistribution under these terms (or, alternatively, under the terms of the ordinary General Public License).

To apply these terms, attach the following notices to the library. It is safest to attach them to the start of each source file to most effectively convey the exclusion of warranty; and each file should have at least the “copyright” line and a pointer to where the full notice is found.

<one line to give the library’s name and an idea of what it does.>
Copyright (C) <year> <name of author>

This library is free software; you can redistribute it and/or modify it under the terms of the GNU Lesser General Public License as published by the Free Software Foundation; either version 2.1 of the License, or (at your option) any later version.

This library is distributed in the hope that it will be useful, but WITHOUT ANY WARRANTY; without even the implied warranty of MERCHANTABILITY or FITNESS FOR A PARTICULAR PURPOSE. See the GNU Lesser General Public License for more details.

You should have received a copy of the GNU Lesser General Public License along with this library; if not, write to the Free Software Foundation, Inc., 59 Temple Place, Suite 330, Boston, MA 02111-1307 USA

Also add information on how to contact you by electronic and paper mail.

You should also get your employer (if you work as a programmer) or your school, if any, to sign a “copyright disclaimer” for the library, if necessary. Here is a sample; alter the names:

Yoyodyne, Inc., hereby disclaims all copyright interest in the library `Frob' (a library for tweaking knobs) written by James Random Hacker.

signature of Ty Coon, 1 April 1990
Ty Coon, President of Vice

That’s all there is to it!

本製品には、以下のライセンスを受けるソフトウェア netkit-base, netkit-ftp, netkit-telnet, portmap が含まれています。
なお、ソースコードの内容についてのお問い合わせはご遠慮ください。

This product includes software netkit-base, netkit-ftp, netkit-telnet, portmap to which the license below applies.
Please note that we cannot respond to inquiries regarding the content of the source code.

Copyright (c) The Regents of the University of California.
All rights reserved.

Redistribution and use in source and binary forms, with or without modification, are permitted provided that the following conditions are met:

1. Redistributions of source code must retain the above copyright notice, this list of conditions and the following disclaimer.
2. Redistributions in binary form must reproduce the above copyright notice, this list of conditions and the following disclaimer in the documentation and/or other materials provided with the distribution.

3. All advertising materials mentioning features or use of this software must display the following acknowledgement:
This product includes software developed by the University of California, Berkeley and its contributors.
4. Neither the name of the University nor the names of its contributors may be used to endorse or promote products derived from this software without specific prior written permission.

THIS SOFTWARE IS PROVIDED BY THE REGENTS AND CONTRIBUTORS "AS IS" AND ANY EXPRESS OR IMPLIED WARRANTIES, INCLUDING, BUT NOT LIMITED TO, THE IMPLIED WARRANTIES OF MERCHANTABILITY AND FITNESS FOR A PARTICULAR PURPOSE ARE DISCLAIMED. IN NO EVENT SHALL THE REGENTS OR CONTRIBUTORS BE LIABLE FOR ANY DIRECT, INDIRECT, INCIDENTAL, SPECIAL, EXEMPLARY, OR CONSEQUENTIAL DAMAGES (INCLUDING, BUT NOT LIMITED TO, PROCUREMENT OF SUBSTITUTE GOODS OR SERVICES; LOSS OF USE, DATA, OR PROFITS; OR BUSINESS INTERRUPTION) HOWEVER CAUSED AND ON ANY THEORY OF LIABILITY, WHETHER IN CONTRACT, STRICT LIABILITY, OR TORT (INCLUDING NEGLIGENCE OR OTHERWISE) ARISING IN ANY WAY OUT OF THE USE OF THIS SOFTWARE, EVEN IF ADVISED OF THE POSSIBILITY OF SUCH DAMAGE.

本製品には、以下のライセンスを受けるソフトウェア `strace` が含まれています。
なお、ソースコードの内容についてのお問い合わせはご遠慮ください。

This product includes software `strace` to which the license below applies.
Please note that we cannot respond to inquiries regarding the content of the source code.

Copyright (c) 1991, 1992 Paul Kranenburg <pk@cs.few.eur.nl>
Copyright (c) 1993 Branko Lankester <branko@hacktic.nl>
Copyright (c) 1993 Ulrich Pegelow <pegelow@moorea.uni-muenster.de>
Copyright (c) 1995, 1996 Michael Elizabeth Chastain <mec@duracef.shout.net>
Copyright (c) 1993, 1994, 1995, 1996 Rick Sladkey <jrs@world.std.com>
Copyright (C) 1998-2001 Wichert Akkerman <wakkerma@deephackmode.org>
All rights reserved.

Redistribution and use in source and binary forms, with or without modification, are permitted provided that the following conditions are met:

1. Redistributions of source code must retain the above copyright notice, this list of conditions and the following disclaimer.
2. Redistributions in binary form must reproduce the above copyright notice, this list of conditions and the following disclaimer in the documentation and/or other materials provided with the distribution.
3. The name of the author may not be used to endorse or promote products derived from this software without specific prior written permission.

THIS SOFTWARE IS PROVIDED BY THE AUTHOR "AS IS" AND ANY EXPRESS OR IMPLIED WARRANTIES, INCLUDING, BUT NOT LIMITED TO, THE IMPLIED WARRANTIES OF MERCHANTABILITY AND FITNESS FOR A PARTICULAR PURPOSE ARE DISCLAIMED.

IN NO EVENT SHALL THE AUTHOR BE LIABLE FOR ANY DIRECT, INDIRECT, INCIDENTAL, SPECIAL, EXEMPLARY, OR CONSEQUENTIAL DAMAGES (INCLUDING, BUT NOT LIMITED TO, PROCUREMENT OF SUBSTITUTE GOODS OR SERVICES; LOSS OF USE, DATA, OR PROFITS; OR BUSINESS INTERRUPTION) HOWEVER CAUSED AND ON ANY THEORY OF LIABILITY, WHETHER IN CONTRACT, STRICT LIABILITY, OR TORT (INCLUDING NEGLIGENCE OR OTHERWISE) ARISING IN ANY WAY OUT OF THE USE OF THIS SOFTWARE, EVEN IF ADVISED OF THE POSSIBILITY OF SUCH DAMAGE.

本製品には、以下のライセンスを受けるソフトウェア `dropbear` が含まれています。
なお、ソースコードの内容についてのお問い合わせはご遠慮ください。

This product includes software `dropbear` to which the license below applies.
Please note that we cannot respond to inquiries regarding the content of the source code.

Copyright (c) 2002-2004 Matt Johnston
Portions copyright (c) 2004 Mihnea Stoenescu
All rights reserved.

Permission is hereby granted, free of charge, to any person obtaining a copy of this software and associated documentation files (the "Software"), to deal in the Software without restriction, including without limitation the rights to use, copy, modify, merge, publish, distribute,

sublicense, and/or sell copies of the Software, and to permit persons to whom the Software is furnished to do so, subject to the following conditions:

The above copyright notice and this permission notice shall be included in all copies or substantial portions of the Software.

THE SOFTWARE IS PROVIDED "AS IS", WITHOUT WARRANTY OF ANY KIND, EXPRESS OR IMPLIED, INCLUDING BUT NOT LIMITED TO THE WARRANTIES OF MERCHANTABILITY, FITNESS FOR A PARTICULAR PURPOSE AND NONINFRINGEMENT. IN NO EVENT SHALL THE AUTHORS OR COPYRIGHT HOLDERS BE LIABLE FOR ANY CLAIM, DAMAGES OR OTHER LIABILITY, WHETHER IN AN ACTION OF CONTRACT, TORT OR OTHERWISE, ARISING FROM, OUT OF OR IN CONNECTION WITH THE SOFTWARE OR THE USE OR OTHER DEALINGS IN THE SOFTWARE.

本製品には、以下のライセンスを受けるソフトウェア expat が含まれています。
なお、ソースコードの内容についてのお問い合わせはご遠慮ください。

This product includes software expat to which the license below applies.
Please note that we cannot respond to inquiries regarding the content of the source code.

Copyright (c) 1998, 1999, 2000 Thai Open Source Software Center Ltd

Permission is hereby granted, free of charge, to any person obtaining a copy of this software and associated documentation files (the "Software"), to deal in the Software without restriction, including without limitation the rights to use, copy, modify, merge, publish, distribute, sublicense, and/or sell copies of the Software, and to permit persons to whom the Software is furnished to do so, subject to the following conditions:

The above copyright notice and this permission notice shall be included in all copies or substantial portions of the Software.

THE SOFTWARE IS PROVIDED "AS IS", WITHOUT WARRANTY OF ANY KIND, EXPRESS OR IMPLIED, INCLUDING BUT NOT LIMITED TO THE WARRANTIES OF MERCHANTABILITY, FITNESS FOR A PARTICULAR PURPOSE AND NONINFRINGEMENT. IN NO EVENT SHALL THE AUTHORS OR COPYRIGHT HOLDERS BE LIABLE FOR ANY CLAIM, DAMAGES OR OTHER LIABILITY, WHETHER IN AN ACTION OF CONTRACT, TORT OR OTHERWISE, ARISING FROM, OUT OF OR IN CONNECTION WITH THE SOFTWARE OR THE USE OR OTHER DEALINGS IN THE SOFTWARE.

本製品には、以下のライセンスを受けるソフトウェア libxml2 が含まれています。
なお、ソースコードの内容についてのお問い合わせはご遠慮ください。

This product includes software libxml2 to which the license below applies.
Please note that we cannot respond to inquiries regarding the content of the source code.

Copyright (C) 1998-2003 Daniel Veillard. All Rights Reserved.

Permission is hereby granted, free of charge, to any person obtaining a copy of this software and associated documentation files (the "Software"), to deal in the Software without restriction, including without limitation the rights to use, copy, modify, merge, publish, distribute, sublicense, and/or sell copies of the Software, and to permit persons to whom the Software is furnished to do so, subject to the following conditions:

The above copyright notice and this permission notice shall be included in all copies or substantial portions of the Software.

THE SOFTWARE IS PROVIDED "AS IS", WITHOUT WARRANTY OF ANY KIND, EXPRESS OR IMPLIED, INCLUDING BUT NOT LIMITED TO THE WARRANTIES OF MERCHANTABILITY, FITNESS FOR A PARTICULAR PURPOSE AND NONINFRINGEMENT. IN NO EVENT SHALL THE DANIEL VEILLARD BE LIABLE FOR ANY CLAIM, DAMAGES OR OTHER LIABILITY, WHETHER IN AN ACTION OF CONTRACT, TORT OR OTHERWISE, ARISING FROM, OUT OF OR IN CONNECTION WITH THE SOFTWARE OR THE USE OR OTHER DEALINGS IN THE SOFTWARE.

Except as contained in this notice, the name of Daniel Veillard shall not be used in advertising or otherwise to promote the sale, use or other dealings in this Software without prior written authorization from him.

本製品には、以下のライセンスを受けるソフトウェアが含まれています。
なお、ソースコードの内容についてのお問い合わせはご遠慮ください。

This product includes software to which the license below applies.
Please note that we cannot respond to inquiries regarding the content of the source code.

Copyright (c) 1998 Red Hat Software

Permission is hereby granted, free of charge, to any person obtaining a copy of this software and associated documentation files (the “Software”), to deal in the Software without restriction, including without limitation the rights to use, copy, modify, merge, publish, distribute, sublicense, and/or sell copies of the Software, and to permit persons to whom the Software is furnished to do so, subject to the following conditions:

The above copyright notice and this permission notice shall be included in all copies or substantial portions of the Software.

THE SOFTWARE IS PROVIDED “AS IS”, WITHOUT WARRANTY OF ANY KIND, EXPRESS OR IMPLIED, INCLUDING BUT NOT LIMITED TO THE WARRANTIES OF MERCHANTABILITY, FITNESS FOR A PARTICULAR PURPOSE AND NONINFRINGEMENT. IN NO EVENT SHALL THE X CONSORTIUM BE LIABLE FOR ANY CLAIM, DAMAGES OR OTHER LIABILITY, WHETHER IN AN ACTION OF CONTRACT, TORT OR OTHERWISE, ARISING FROM, OUT OF OR IN CONNECTION WITH THE SOFTWARE OR THE USE OR OTHER DEALINGS IN THE SOFTWARE.

Except as contained in this notice, the name of the X Consortium shall not be used in advertising or otherwise to promote the sale, use or other dealings in this Software without prior written authorization from the X Consortium.

本製品は、OpenSSL Toolkit (<http://www.openssl.org/>) で利用するために、OpenSSL Project により開発されたソフトウェアを含んでいます。
なお、ソースコードの内容についてのお問い合わせはご遠慮ください。

This product includes software developed by the OpenSSL Project for use in the OpenSSL Toolkit. (<http://www.openssl.org/>).
Please note that we cannot respond to inquiries regarding the content of the source code.

OpenSSL License

Copyright (c) 1998-2005 The OpenSSL Project. All rights reserved.

Redistribution and use in source and binary forms, with or without modification, are permitted provided that the following conditions are met:

1. Redistributions of source code must retain the above copyright notice, this list of conditions and the following disclaimer.
2. Redistributions in binary form must reproduce the above copyright notice, this list of conditions and the following disclaimer in the documentation and/or other materials provided with the distribution.
3. All advertising materials mentioning features or use of this software must display the following acknowledgment:
“This product includes software developed by the OpenSSL Project for use in the OpenSSL Toolkit. (<http://www.openssl.org/>)”
4. The names “OpenSSL Toolkit” and “OpenSSL Project” must not be used to endorse or promote products derived from this software without prior written permission. For written permission, please contact openssl-core@openssl.org.
5. Products derived from this software may not be called “OpenSSL” nor may “OpenSSL” appear in their names without prior written permission of the OpenSSL Project.
6. Redistributions of any form whatsoever must retain the following acknowledgment:
“This product includes software developed by the OpenSSL Project for use in the OpenSSL Toolkit (<http://www.openssl.org/>)”

THIS SOFTWARE IS PROVIDED BY THE OpenSSL PROJECT “AS IS” AND ANY EXPRESSED OR IMPLIED WARRANTIES, INCLUDING, BUT NOT LIMITED TO, THE IMPLIED WARRANTIES OF MERCHANTABILITY AND FITNESS FOR A PARTICULAR PURPOSE ARE DISCLAIMED. IN NO EVENT SHALL THE OpenSSL PROJECT OR ITS CONTRIBUTORS BE LIABLE FOR ANY DIRECT, INDIRECT, INCIDENTAL, SPECIAL, EXEMPLARY, OR CONSEQUENTIAL DAMAGES (INCLUDING, BUT NOT LIMITED TO, PROCUREMENT OF SUBSTITUTE GOODS OR SERVICES; LOSS OF USE, DATA, OR PROFITS; OR BUSINESS INTERRUPTION)

HOWEVER CAUSED AND ON ANY THEORY OF LIABILITY, WHETHER IN CONTRACT, STRICT LIABILITY, OR TORT (INCLUDING NEGLIGENCE OR OTHERWISE) ARISING IN ANY WAY OUT OF THE USE OF THIS SOFTWARE, EVEN IF ADVISED OF THE POSSIBILITY OF SUCH DAMAGE.

This product includes cryptographic software written by Eric Young (eay@cryptsoft.com). This product includes software written by Tim Hudson (tjh@cryptsoft.com).

Original SSLeay License

Copyright (C) 1995-1998 Eric Young (eay@cryptsoft.com)
All rights reserved.

This package is an SSL implementation written by Eric Young (eay@cryptsoft.com).
The implementation was written so as to conform with Netscapes SSL.

This library is free for commercial and non-commercial use as long as the following conditions are adhered to. The following conditions apply to all code found in this distribution, be it the RC4, RSA, lhash, DES, etc., code; not just the SSL code. The SSL documentation included with this distribution is covered by the same copyright terms except that the holder is Tim Hudson (tjh@cryptsoft.com).

Copyright remains Eric Young's, and as such any Copyright notices in the code are not to be removed. If this package is used in a product, Eric Young should be given attribution as the author of the parts of the library used. This can be in the form of a textual message at program startup or in documentation (online or textual) provided with the package.

Redistribution and use in source and binary forms, with or without modification, are permitted provided that the following conditions are met:

1. Redistributions of source code must retain the copyright notice, this list of conditions and the following disclaimer.
2. Redistributions in binary form must reproduce the above copyright notice, this list of conditions and the following disclaimer in the documentation and/or other materials provided with the distribution.
3. All advertising materials mentioning features or use of this software must display the following acknowledgement: "This product includes cryptographic software written by Eric Young (eay@cryptsoft.com)" The word 'cryptographic' can be left out if the routines from the library being used are not cryptographic related :-).
4. If you include any Windows specific code (or a derivative thereof) from the apps directory (application code) you must include an acknowledgement: "This product includes software written by Tim Hudson (tjh@cryptsoft.com)"

THIS SOFTWARE IS PROVIDED BY ERIC YOUNG "AS IS" AND ANY EXPRESS OR IMPLIED WARRANTIES, INCLUDING, BUT NOT LIMITED TO, THE IMPLIED WARRANTIES OF MERCHANTABILITY AND FITNESS FOR A PARTICULAR PURPOSE ARE DISCLAIMED. IN NO EVENT SHALL THE AUTHOR OR CONTRIBUTORS BE LIABLE FOR ANY DIRECT, INDIRECT, INCIDENTAL, SPECIAL, EXEMPLARY, OR CONSEQUENTIAL DAMAGES (INCLUDING, BUT NOT LIMITED TO, PROCUREMENT OF SUBSTITUTE GOODS OR SERVICES; LOSS OF USE, DATA, OR PROFITS; OR BUSINESS INTERRUPTION) HOWEVER CAUSED AND ON ANY THEORY OF LIABILITY, WHETHER IN CONTRACT, STRICT LIABILITY, OR TORT (INCLUDING NEGLIGENCE OR OTHERWISE) ARISING IN ANY WAY OUT OF THE USE OF THIS SOFTWARE, EVEN IF ADVISED OF THE POSSIBILITY OF SUCH DAMAGE.

The licence and distribution terms for any publically available version or derivative of this code cannot be changed. i.e. this code cannot simply be copied and put under another distribution licence [including the GNU Public Licence.]

本製品には、以下のライセンスを受けるソフトウェア ntp が含まれています。
なお、ソースコードの内容についてのお問い合わせはご遠慮ください。

This product includes software ntp to which the license below applies.
Please note that we cannot respond to inquiries regarding the content of the source code.

Copyright (c) David L. Mills 1992-2003

Permission to use, copy, modify, and distribute this software and its documentation for any purpose and without fee is hereby granted, provided that the above copyright notice appears in all copies and that both the copyright notice and this permission notice appear in supporting documentation, and that the name University of Delaware not be used in advertising or publicity pertaining to distribution of the software

without specific, written prior permission. The University of Delaware makes no representations about the suitability this software for any purpose. It is provided “as is” without express or implied warranty.

本製品には、以下のライセンスを受けるソフトウェア tcp_wrappers が含まれています。
なお、ソースコードの内容についてのお問い合わせはご遠慮ください。

This product includes software tcp wrappers to which the license below applies.
Please note that we cannot respond to inquiries regarding the content of the source code.

Copyright 1995 by Wietse Venema. All rights reserved. Some individual files may be covered by other copyrights.

This material was originally written and compiled by Wietse Venema at Eindhoven University of Technology, The Netherlands, in 1990, 1991, 1992, 1993, 1994 and 1995.

Redistribution and use in source and binary forms are permitted provided that this entire copyright notice is duplicated in all such copies.

This software is provided “as is” and without any expressed or implied warranties, including, without limitation, the implied warranties of merchantability and fitness for any particular purpose.

本製品には、以下のライセンスを受けるソフトウェア thttpd が含まれています。
なお、ソースコードの内容についてのお問い合わせはご遠慮ください。

This product includes software thttpd to which the license below applies.
Please note that we cannot respond to inquiries regarding the content of the source code.

Copyright © 1995,1998,1999,2000,2001 by Jef Poskanzer <jef@acme.com>.
All rights reserved.

Redistribution and use in source and binary forms, with or without modification, are permitted provided that the following conditions are met:

1. Redistributions of source code must retain the above copyright notice, this list of conditions and the following disclaimer.
2. Redistributions in binary form must reproduce the above copyright notice, this list of conditions and the following disclaimer in the documentation and/or other materials provided with the distribution.

THIS SOFTWARE IS PROVIDED BY THE AUTHOR AND CONTRIBUTORS “AS IS” AND ANY EXPRESS OR IMPLIED WARRANTIES, INCLUDING, BUT NOT LIMITED TO, THE IMPLIED WARRANTIES OF MERCHANTABILITY AND FITNESS FOR A PARTICULAR PURPOSE ARE DISCLAIMED. IN NO EVENT SHALL THE AUTHOR OR CONTRIBUTORS BE LIABLE FOR ANY DIRECT, INDIRECT, INCIDENTAL, SPECIAL, EXEMPLARY, OR CONSEQUENTIAL DAMAGES (INCLUDING, BUT NOT LIMITED TO, PROCUREMENT OF SUBSTITUTE GOODS OR SERVICES; LOSS OF USE, DATA, OR PROFITS; OR BUSINESS INTERRUPTION) HOWEVER CAUSED AND ON ANY THEORY OF LIABILITY, WHETHER IN CONTRACT, STRICT LIABILITY, OR TORT (INCLUDING NEGLIGENCE OR OTHERWISE) ARISING IN ANY WAY OUT OF THE USE OF THIS SOFTWARE, EVEN IF ADVISED OF THE POSSIBILITY OF SUCH DAMAGE.

このマニュアルに記載されている事柄の著作権は当社にあり、説明内容は機器購入者の使用を目的としています。したがって当社の許可なしに無断で複製したり、説明内容（操作、保守等）と異なる目的で本マニュアルをしようすることを禁止します。

The material contained in this manual consist of information that is the property of Sony Corporation and is intended solely for use by purchasers of the equipment described in this manual.
Sony Corporation expressly prohibits the duplication of any portion of this manual or the use thereof for any purpose other than the operation or maintenance of the equipment described in this manual without the express written permission of Sony Corporation.

商標について

- 「CineAlta 4K」およびそのロゴマークは、ソニー株式会社の登録商標です。
- Ethernet は Xerox 社の登録商標です。

Trademark

- “CineAlta 4K” and its logomark are registered trademarks of Sony Corporation.
- Ethernet is a registered trademark of Xerox Corporation.

For Customer in China

根据中华人民共和国信息产业部第39号令《电子信息产品污染控制管理办法》及标准中要求的“有毒有害物质或元素名称及含量”等信息，本产品相关信息请参考以下链接：

<http://pro.sony.com.cn>

<http://www.sony.net/>

Printed in Japan



この説明書は、再生紙を使用しています。
Printed on recycled paper.

お問い合わせは
「ソニー業務用製品ご相談窓口のご案内」にある窓口へ

ソニー株式会社 〒108-0075 東京都港区港南1-7-1