

HXR-NX3D1U

NXCAM 3D Compact Camcorder

SONY

make.believe



The HXR-NX3D1U, a Double Full HD 3D Camcorder Offering Professionals a New Level of Flexibility and Workflow Convenience

A Compact 3D Camcorder for Professionals

The HXR-NX3D1U is an extremely compact, ready to shoot 3D camcorder, weighing only approx. 1150g. (w/Hood, w/Battery, w/Microphone, w/XLR adaptor)

Until now, shooting 3D movies with a 3D rig involved difficult, time-consuming alignment adjustment for each scene. It was also hard to produce 3D videos with a small budget. With the HXR-NX3D1U, simply adjusting left-right disparity, without spending time adjusting the left and right lenses, is all that's required to shoot 3D footage. Providing a fast simple and, inexpensive way for 3D video production, this new camcorder opens the door to a whole new world of 3D content possibilities. Boasting exceptional flexibility with its compact and lightweight design to enable 3D shooting at camera angles that were never possible before, the HXR-NX3D1U is the ideal sub camera in a 3D production system.



NXCAM

AVCHD
3D/Progressive

MPEG2 SD

Exmor R
CMOS Sensor

MEMORY STICK

SD
XC

G
Sony Lens G

Double "Sony Lens G" and Double "Exmor R" CMOS sensors

Inside the HXR-NX3D1U's compact body there are two separate cameras each featuring a high quality SONY G lens and a high-sensitivity, back-illuminated "Exmor R" CMOS sensor. High-quality,

1920x1080 Full HD left and right images enable recording of incredibly realistic 3D movies.



Optical SteadyShot w/Active Mode and 10x Optical Zoom (34.4-344mm) in 3D

One of the most important considerations during 3D shooting is obtaining stable images to prevent audience discomfort during viewing. The HXR-NX3D1U features the Optical SteadyShot w/Active Mode with 3-way camera shake stabilizing technology that smooths out up/down, left/right and rolling motion when shooting in 3D. Capturing stable 3D images with minimal shake is possible even for

hand-held shooting.

When shooting in 3D, the HXR-NX3D1U lets you zoom from 34.4mm to 344mm (35mm equivalent). Frame composition while zooming is also possible just like in 2D shooting.

3D Shooting with Two Parallel Cameras

The HXR-NX3D1U features two parallel lenses mounted 31mm apart. (the inter-axial distance is 31mm) Disparity adjustment can be performed to change the read-out areas of the left and right CMOS sensors so that they are closer together or further apart. This lets you control perceived 3D depth and the proximity of regions of interest to a virtual screen. Disparity adjustment is also possible during shooting using the manual dial. Moving a region of interest closer to the virtual screen enables shooting of comfortable 3D images with the desired feeling of depth.

*When capturing 3D images, the minimum shooting distance is 80cm (at wide-angle setting)

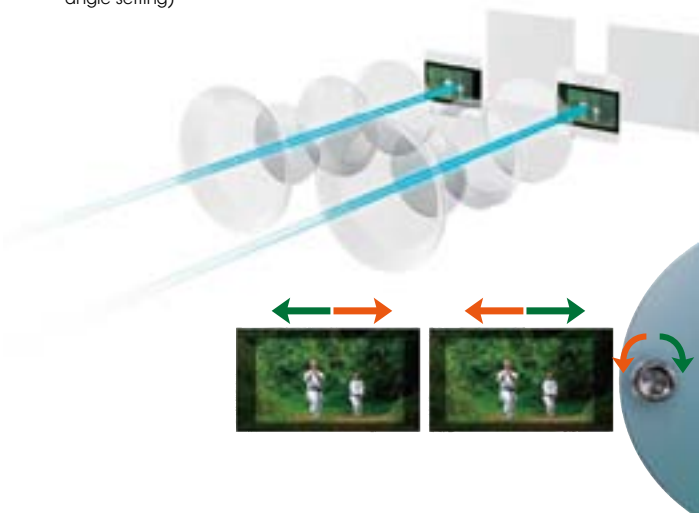

3.5" Xtra Fine LCD™ display (1229K) Providing User-Selectable 2D or Glassless 3D Viewing

The HXR-NX3D1U's glassless 3D LCD lets you preview high-quality 3D images while shooting. Switching between 2D and 3D display is also possible. On top of that, a separate display mode for left or right images, and an L/R composite mix of left and right images are also available for easier confirmation of disparity.

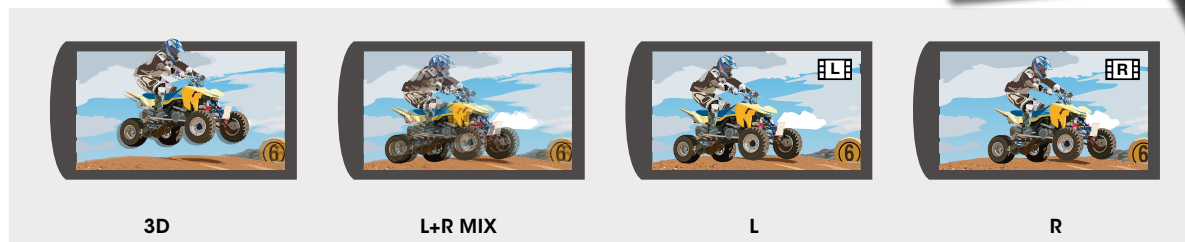

User-Selectable HDMI output format: Frame Packing and Side by Side

Output from the HXR-NX3D1U's HDMI jack to a 3D TV is selectable between Frame Packing with Full HD output of alternate left and right images, and Side by Side with output of horizontally compressed left and right images packed into a single frame. Select the Frame Packing mode for a 3D TV (Sony BRAVIA) and the Side by Side mode for a professional 3D monitor. Connection is also possible via an HDMI-HD-SDI converter to enable compatibility with a wide range of 3D monitors.

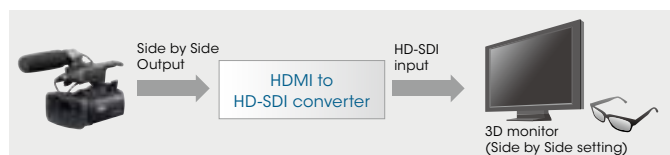

Multi-Format Recording (3D 60i/50i/24p & 2D 60p/60i/50p/50i/25p/24p)

Compatible with a wide range of formats, the HXR-NX3D1U enables 1080/60i/ 50i/24p 3D recording and 1080 60p/60i/50p/50i/25p/24p 2D recording.



Large Capacity, Internal 96GB Memory and Memory Stick/SD Multi Card Slot

The HXR-NX3D1U has a 96GB internal memory, enabling extended recording in 3D mode for approximately 7.5 hours. And there's a multi-card card slot that lets you record video images on Memory Sticks and SD Cards. You can also use these convenient recordable media to copy data from the internal memory.



Approximate Recording Time

HD MOVIE

Linear PCM 2ch	3D / HD PS (28M)	HD FX (24M)	HD FH (17M)	HD HQ (9M)	HD LP (5M)	(Unit:min)
1 GB Memory Card	4	4	6	10	15	
2 GB Memory Card	8	10	10	20	35	
4 GB Memory Card	15	20	25	45	70	
8 GB Memory Card	35	40	55	90	145	
16 GB Memory Card	70	80	110	185	295	
32 GB Memory Card	145	170	225	375	590	
Internal Memory (96 GB)	450	530	705	1170	1850	

STD MOVIE

Dolby Digital 2ch	SD/STD 9M (HQ)	(Unit:min)
1 GB Memory Card	10	
2 GB Memory Card	25	
4 GB Memory Card	55	
8 GB Memory Card	110	
16 GB Memory Card	225	
32 GB Memory Card	460	
Internal Memory (96 GB)	1435	

Note: The recording time is approximate. The Maximum continuous recordable time of movies is about 13 hours. The recording time may vary depending on the recording conditions, subjects.

Single 3D Recording File for Easy Editing and 2D NLE Compatibility

Easy workflow is an important consideration when creating 3D footage. The HXR-NX3D1U uses Multi-View Coding (MVC) to record left and right channel clips as a single file. Sony Vegas Pro 10.0d offers native import support for MVC video files, so footage can be directly handled as 3D clips to enable import of left and right channel clips together. By eliminating the need for time-consuming pairing, this provides an extremely simple workflow.

And Vegas Pro 10.0e provides the ability to adjust, edit, preview, and output stereoscopic 3D Blu-ray Disc and 3D media with side-by-side, top/bottom, or line-alternate encoding.



Support is scheduled to enable conversion of MVC footage recorded with the HXR-NX3D1U to Cineform codec using the popular Cineform Neo3D/Neo as a Codec Plug-In for 3D editing.

neo3d

Content Management Utility enables conversion of MVC to left and right channels

The supplied Content Management Utility 2.1 software also enables conversion of MVC video files to 2D AVC files with independent left and right channels. With these capabilities the HXR-NX3D1U is ready for a wide range of workflows.



Content Management Utility System Requirements

- Microsoft® Windows® XP Service Pack3 (32 bit), Windows Vista® Service Pack2 (32 bit / 64 bit), Windows® 7
- Intel® Core™2 Duo 2.80 GHz (for AVCHD playback)
- 1 GB of RAM
- 100 MB available hard-disk space for installation
- 1024 x 768 display

XLR Adaptor with Selectable Phantom Power and ECM-XM1 Shotgun Microphone Enabling High-Quality Linear PCM Recording

The detachable handle has an ergonomic design that is comfortable and compact. Two balanced XLR audio inputs are built in with phantom power and attenuation options that professional shooters require for clean sound quality. Default audio settings for XLR recording are highlighted in green for easy reference in the field in order to reduce operator error under difficult lighting conditions.

The ECM-XM1 shotgun microphone mounted on top of the handle provides audio recording performance similar to larger shoulder-mounted ENG style cameras.



Direct Copy to External HDD without a PC

Important shots can be backed up by copying footage directly from the HXR-NX3D1U to an external hard disk drive (sold separately) without the need for a computer. The HXR-NX3D1U can also access videos stored on the external hard drive for playback on a 3D HDTV, allowing you to utilize the camcorder's handy 3D playback features.



1. Direct Copy is compatible with USB media that meets the following requirements

- USB media that meets the USB2.0 requirement.
- For external HDD or USB memory under 2TB, an AC powered external HDD is recommended.
- USB media formatted in the FAT32 file system. In the case when USB media is not in FAT32 file system, reformatting is required and all data will be erased.

Note: There may be cases when USB media is not compatible with the Direct Copy function.

2. When using Direct Copy the camcorder needs to be connected to AC power.
3. Using VMC-UAM1 (supplied) cable when the HXR-NX3D1U is connected to External HDD.
4. Connection via USB-hub is not supported.

Accessories

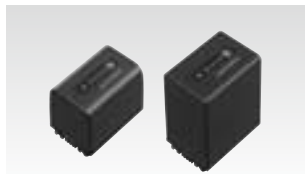

Rechargeable Battery Pack
NP-FV70
(6.8 V / 14.0 Wh / 2060 mAh)
NP-FV100
(6.8 V / 26.5 Wh / 3900 mAh)



AC Adaptor/Charger
AC-VQV10
(AC 100 V – 240 V)



Battery Charger
BC-TRV
(AC 100 V – 240 V)



Accessory Kit
ACC-V1BP
(Include NP-FV100 and AC-VQV10)



Accessory Kit
ACC-VA1BP
(include NP-FV70, BC-TRV, RM-VD1 etc)



Memory Stick PRO-HG Duo™
MS-HX32A
(32 GB, 16 GB, 8 GB)
Memory Stick PRO Duo™
MS-MT32G
(32 GB, 16 GB, 8 GB, 4 GB, 2 GB)



SD / SDHC Memory Card
SF-32N4
(32 GB, 16 GB, 8 GB, 4 GB, 2 GB)
SF-32NX
(32 GB, 16 GB, 8 GB)

Specifications

General		
Mass	(w/ Battery)	745g (Approx.)
	(w/Hood, w/ Battery, w/Microphone, w/ XLR unit)	1,150g (Approx.)
Dimension (W x H x D)	(w/ Battery)	86.5x79.0x148.5mm, 3 1/2x3 1/8x 5 7/8inch (Approx.)
	(w/Hood, w/ Battery, w/Microphone, w/ XLR unit)	124.5x165.5x262.5mm, 5x6 5/8x10 3/8inch (Approx.)
Power requirements	Power Requirements (AC adaptor / Battery)	8.4V/6.8V
Power consumption	LCD - normal brightness (HD FX)	4.0W
	LCD - normal brightness (3D)	5.4W
Operating temperature		0 to +40 deg C (+32 to +104 deg F)
Storage temperature		-20 to +60 deg C (-4 to +140 deg F)
Battery operating time	Continuous recording time	190min (HD), 140min (3D)
Recording format	Video Format	3D HD : MPEG-4 MVC/H.264 AVCHD format Ver.2.0 compatible
		2D HD : MPEG-4 AVC/H.264 AVCHD format Ver.2.0 compatible
		STD : MPEG-2 PS
	Audio Format	3D HD/2D HD : Linear PCM/Dolby Digital 2ch, 16bit, 48kHz
	STD : Dolby Digital 2ch, 16bit, 48kHz	
Recording frame rate*1	3D HD	3D (28Mbps) 1920 x 1080/(60i,50i,24p)/16:9
	2D HD	PS (28Mbps) 1920 x 1080/(60p,50p)/16:9
		FX (24Mbps) 1920 x 1080/(60i,50i,25p,24p)/16:9
		FH (17Mbps) 1920 x 1080/(60i,50i,25p,24p)/16:9
		HQ (9Mbps) 1440 x 1080/(60i,50i)/16:9
		LP (5Mbps) 1440 x 1080/(60i,50i)/16:9
STD	SD (9Mbps) 720 x 480/60i or 720 x 576/50i/16:9, 4:3	
Recording / Playback time		145min (MS 32GB, 3D, LPCM)
		170min (MS 32GB, HD FX, LPCM)
		450min (Int. memory 96GB, 3D, LPCM)
		530min (Int. memory 96GB, HD FX, LPCM)
Zoom ratio		Sony G Lens, 10x (optical in 3D), 12x (optical in 2D)
Focal length		f = 2.9mm - 29mm (equivalent to 34.4mm - 344 mm (16:9 in 3D)*2,
		f = 2.9mm - 34.8mm (equivalent to 29.8mm - 357.6mm (16:9 in 2D)*2
Focus		Full range auto/Manual
Image stabilizer		Optical SteadyShot™ image stabilization w/ Active mode (Wide to Tele)
Camera Section		
Imaging device		1/4 type ExmorR CMOS with ClearVid pixel array
		Pixel Gross:Approx. 4,200K Video Actual:Approx. 1,990K (16:9)
Minimum illumination		3 lux (Low LUX mode, 1/30 (60p or 60i) 1/25 (50p or 50i) shutter 2D only), 11 lux (Standard mode)
Shutter speed		1/8 - 1/1,000 (Manual Shutter Speed Control)
Iris		F1.8 - F3.4
Slow & Quick Motion function (2D only)		240 fps (fixed, 60i), 200 fps (fixed, 50i) as Smooth Slow Rec *The picture quality is degraded. (fps : Field per Sec.)
White balance		Auto, outdoor (5,800K), indoor (3,200K), One-push (Touch panel)
Inputs/Outputs		
Mic input		Stereo mini jack (x 1) ø3.5mm
Audio input		XLR 3-Pin (female) (x2), LINE / MIC / MIC+48V selectable
A/V Output		A/V Remote connector
Component Video Output		A/V Remote connector
USB		USB device, Mini-AB / Hi-Speed (x 1)
Headphone output		Stereo mini jack (x 1) ø3.5mm
HDMI output		HDMI mini connector (x 1)
Monitoring		
Built-in LCD monitor		8.8cm (3.5 type, aspect ratio 16:9) 1,229,760 dots (2D 2562x480) 2D / 3D view selectable
Built-In Microphone		
		2ch Stereo microphone
Recording Media		
Internal Memory		96GB
Type		Memory Stick PRO Duo (Mark2), Memory Stick PRO-HG Duo, Memory Stick PRO-HG Duo HX SD / SDHC / SDXC Memory Card*3
Supplied Accessories		
		AC Adaptor, Power code, Rechargeable Battery Pack, Microphone, Wind Screen, XLR Adaptor, Lens hood, USB cable (mini-B), Component A/V cable, A/V connecting cable, USB Adaptor cable (for external HDD), Wireless Remote Commander, HDMI cable (typeC), Application Software (CD-ROM)

*1 Due to variable bitrate, 28Mbps is the maximum bitrate for 3D mode and HD PS mode, 24Mbps for HD FX mode. The average bitrate is started for FH, HQ and LP modes.

*2 The focal length is when SteadyShot mode is in Active mode Off.

*3 Class 4 or faster.

Dimensions

Unit: mm (inches)

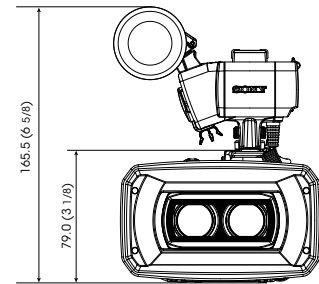
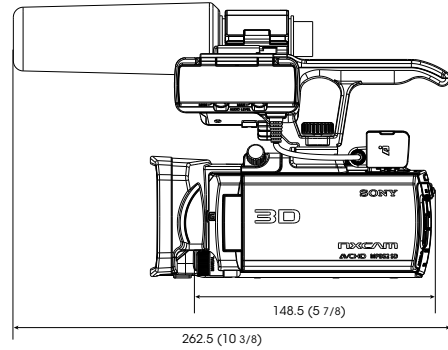
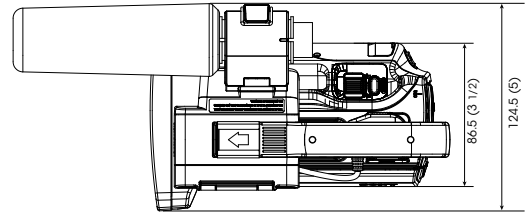

Supplied Accessories



Distributed by

©2011 Sony Corporation. All rights reserved. Reproduction in whole or in part without written permissions is prohibited. Features and specifications are subject to change without notice.

The values for weight and dimension are approximate. Sony and Sony logo are trademarks of Sony Corporation. G Lens, Exmor, InfoLITHIUM, Memory Stick, Memory Stick PRO Duo, Memory Stick PRO-HG Duo are registered trademark of Sony Corporation.

AVCHD and AVCHD logo are trademarks of Panasonic Corporation and Sony Corporation. Windows is a registered trademark of Microsoft Corporation in the United States and other countries.

Dolby is a trademark of Dolby Laboratories. SD, SDHC and SDXC logos are trademarks of SD-3C, LLC. All other trademarks are the property of their respective owners.